

12029

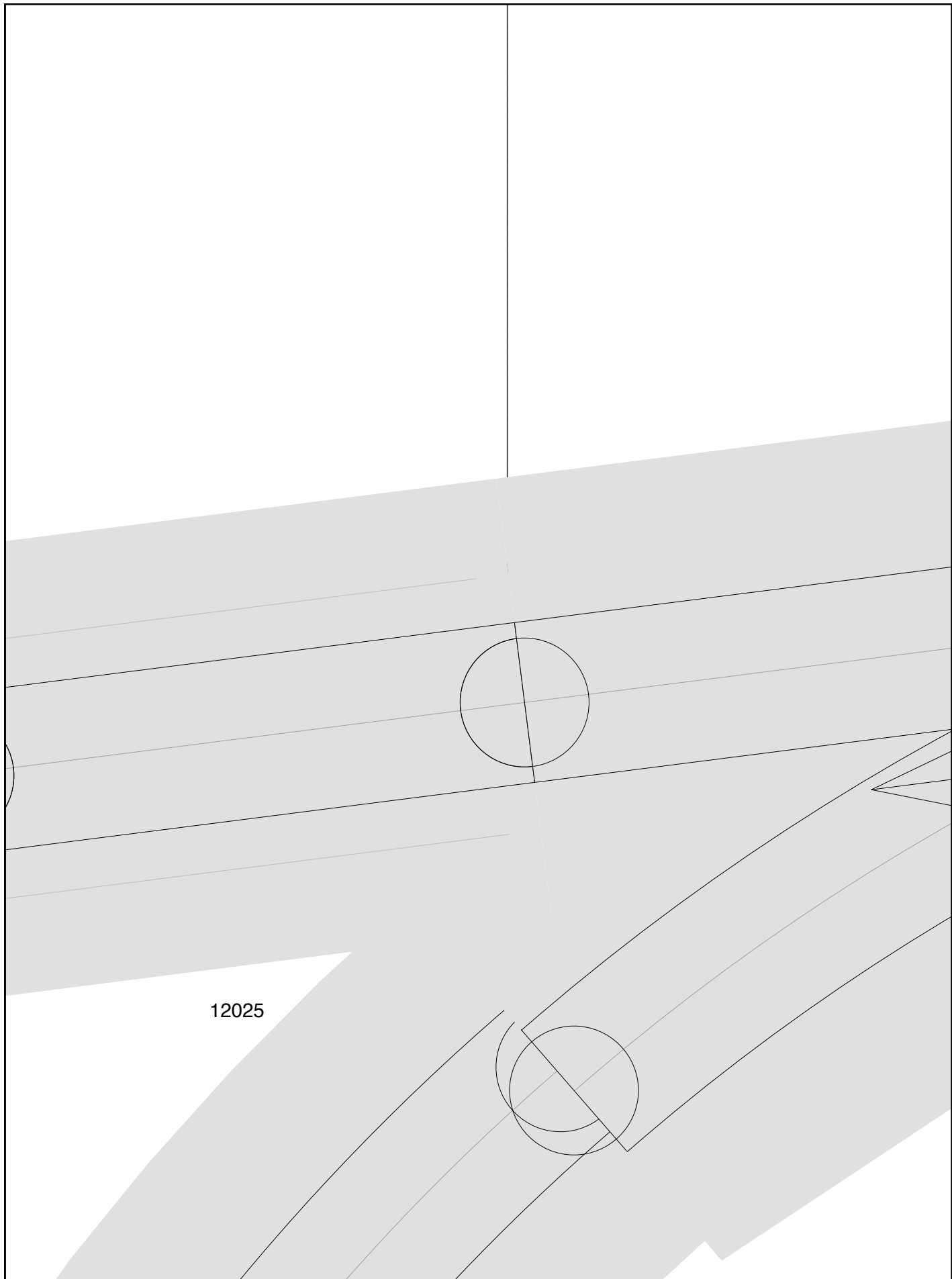

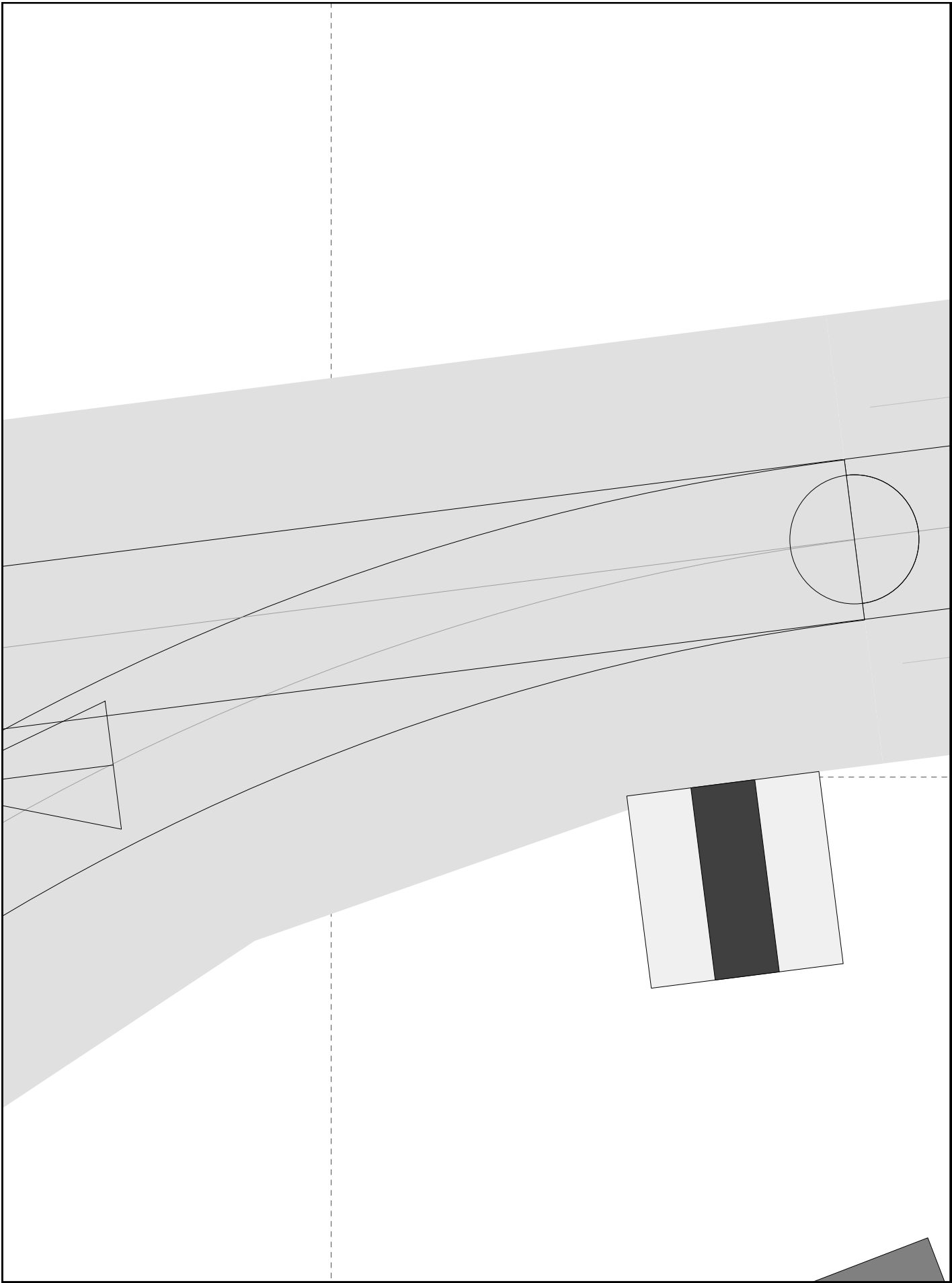

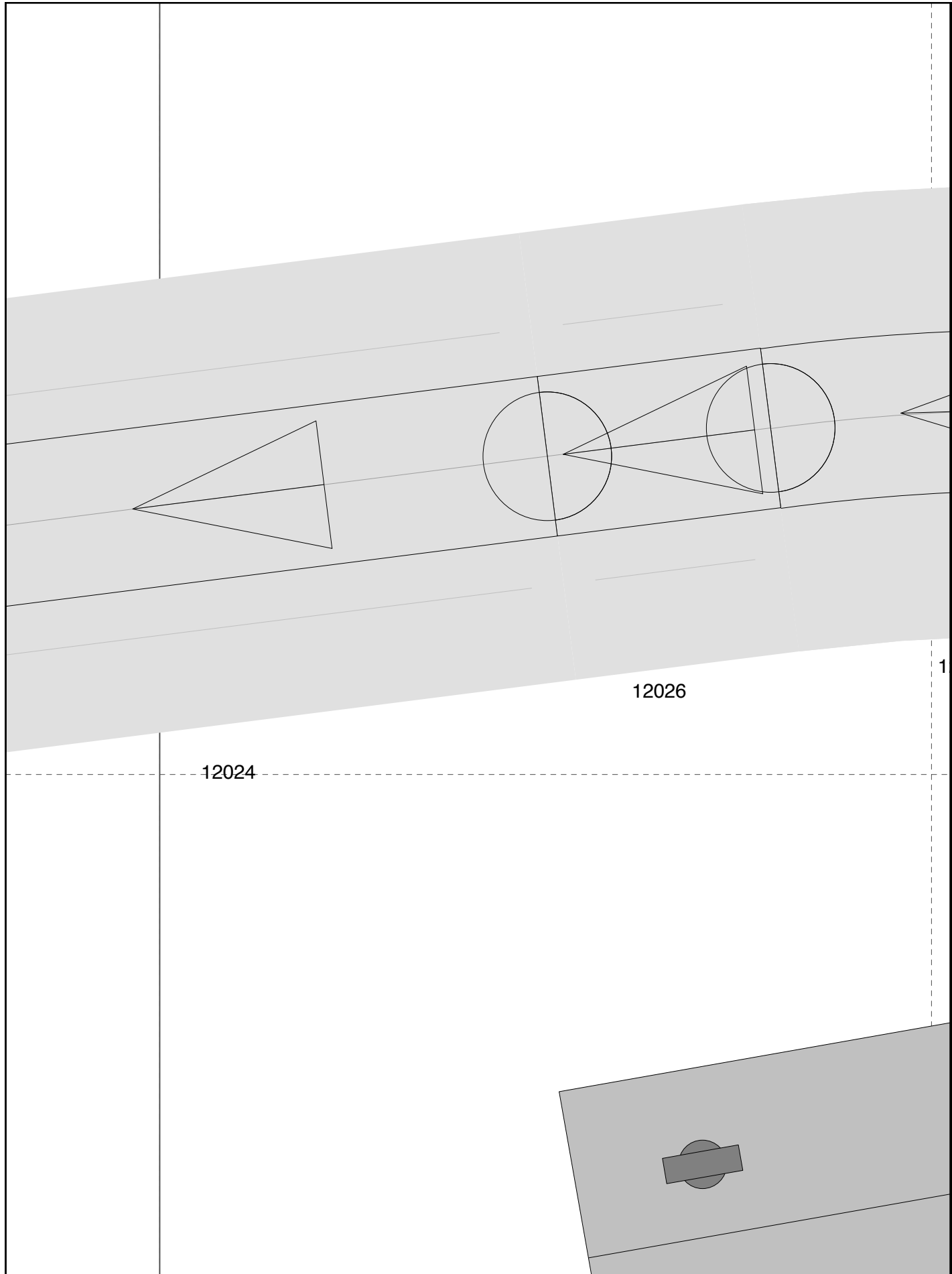



12024

12026

1

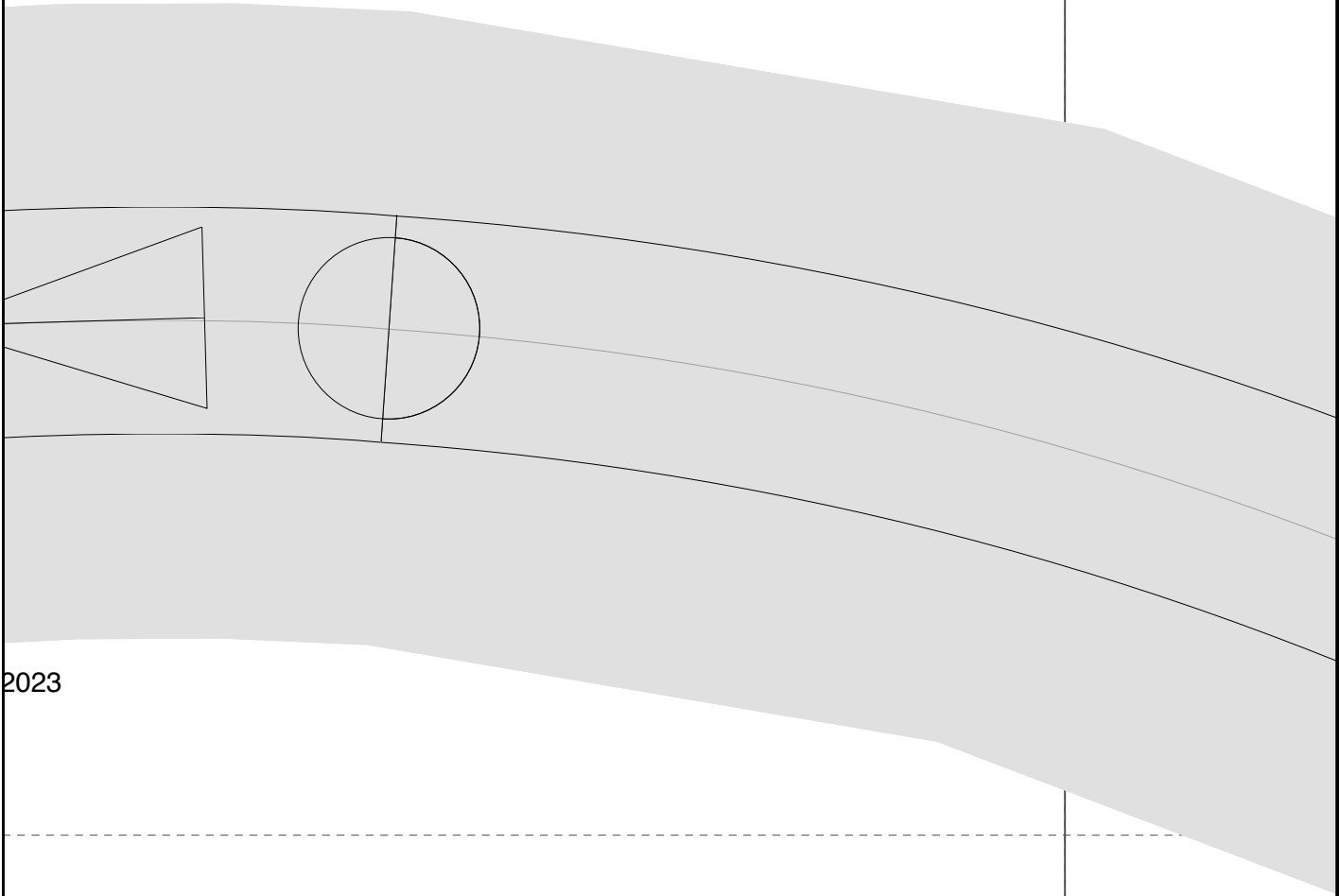

2023

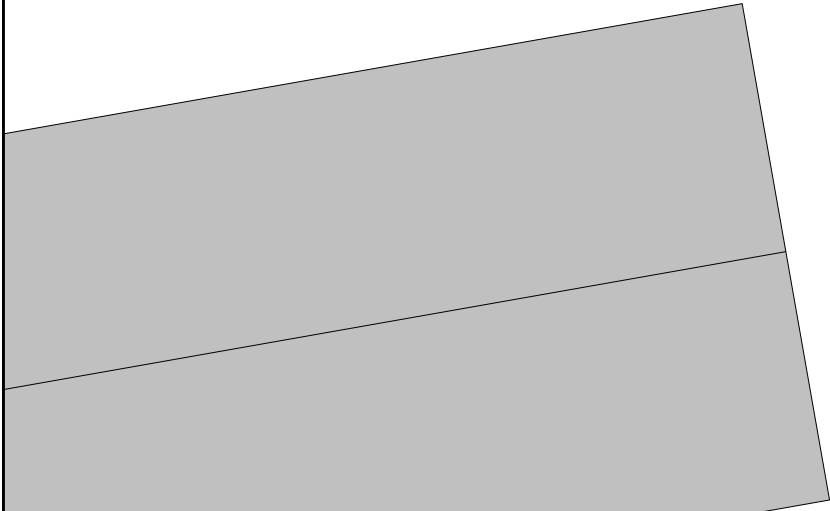

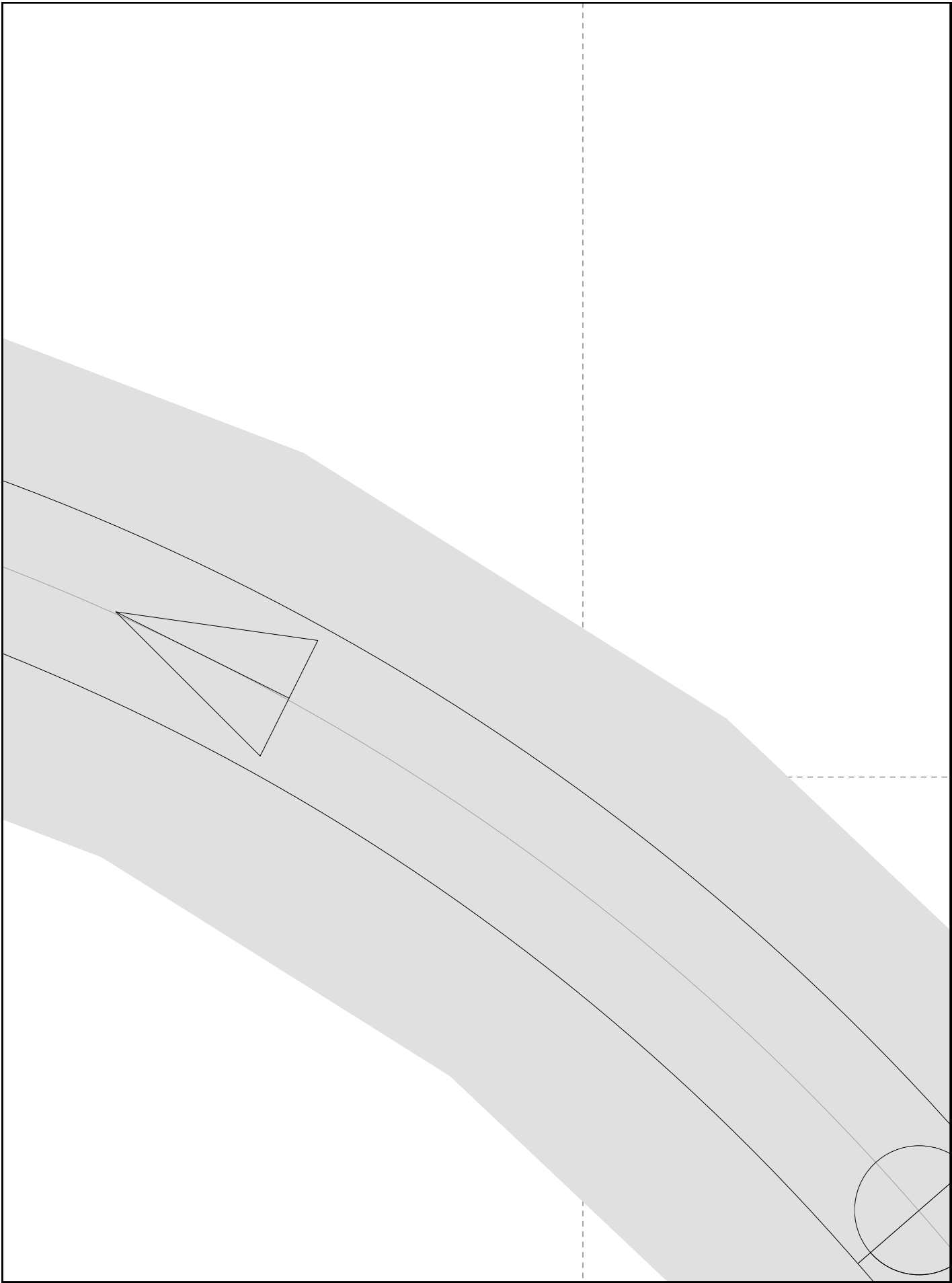

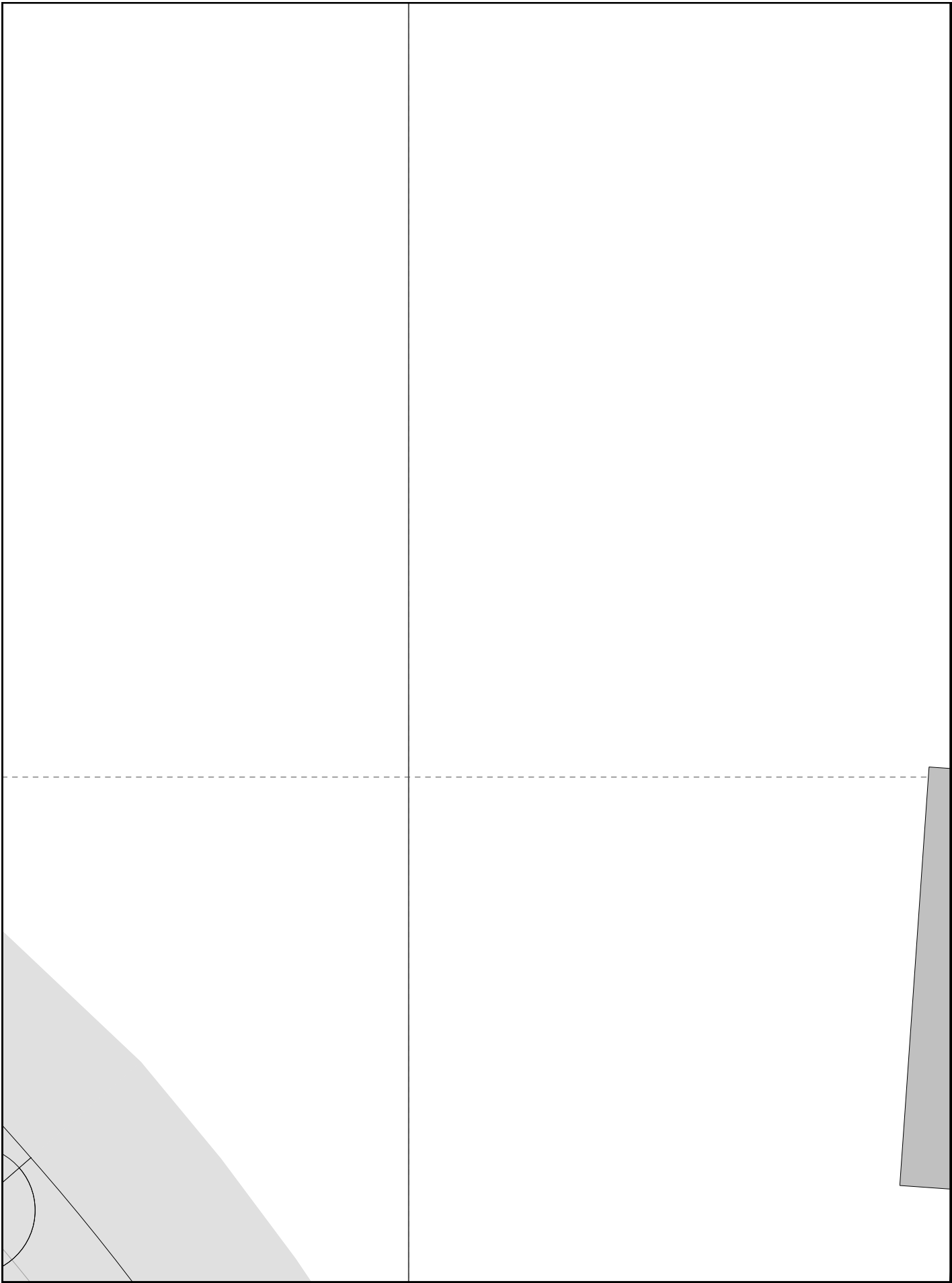

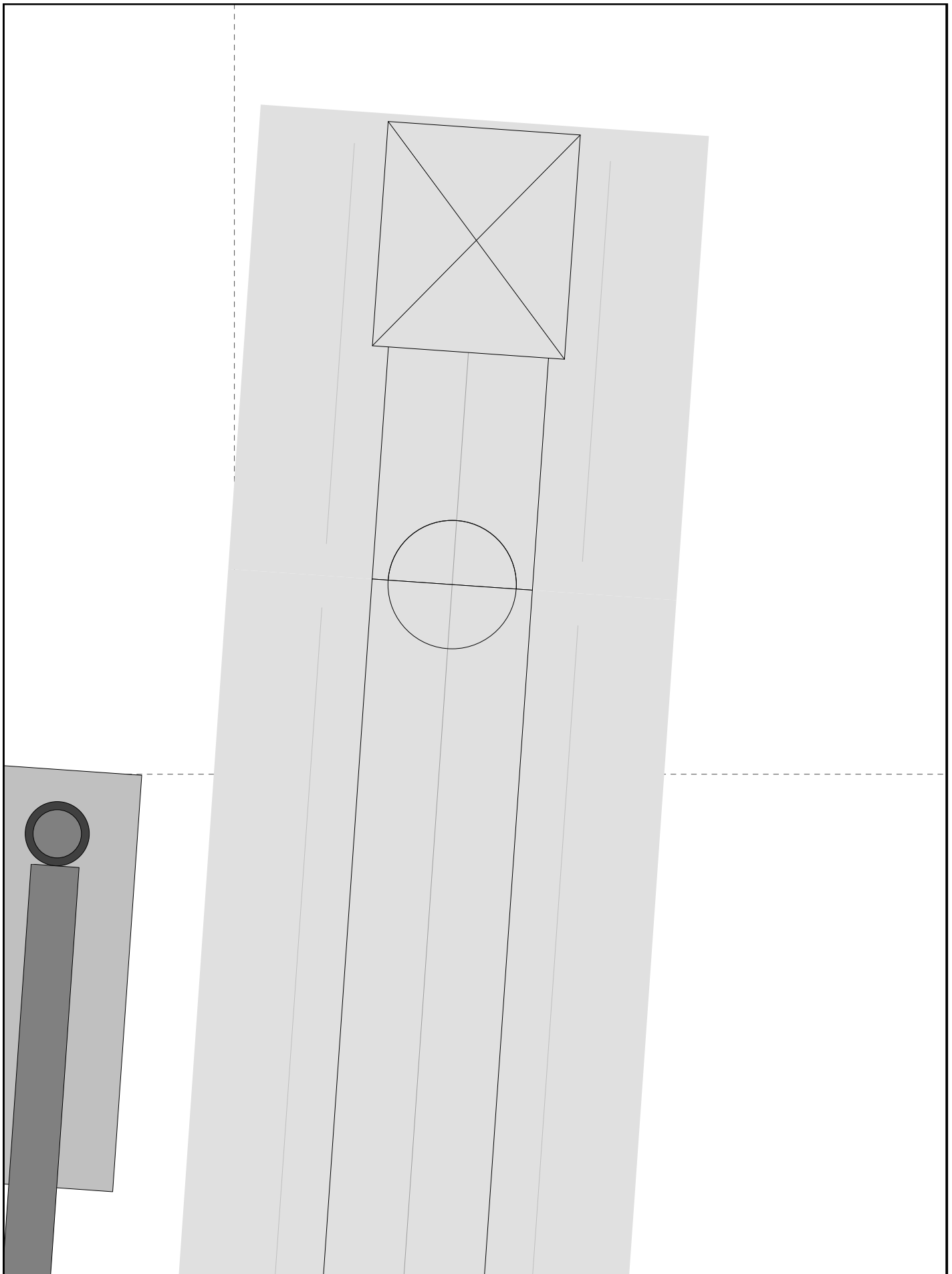

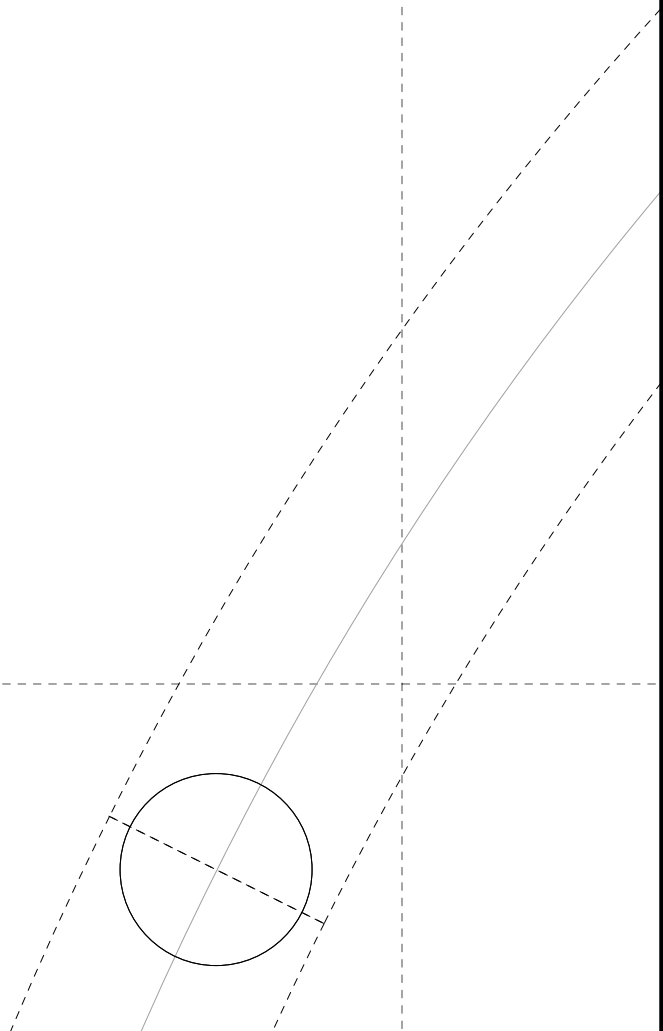

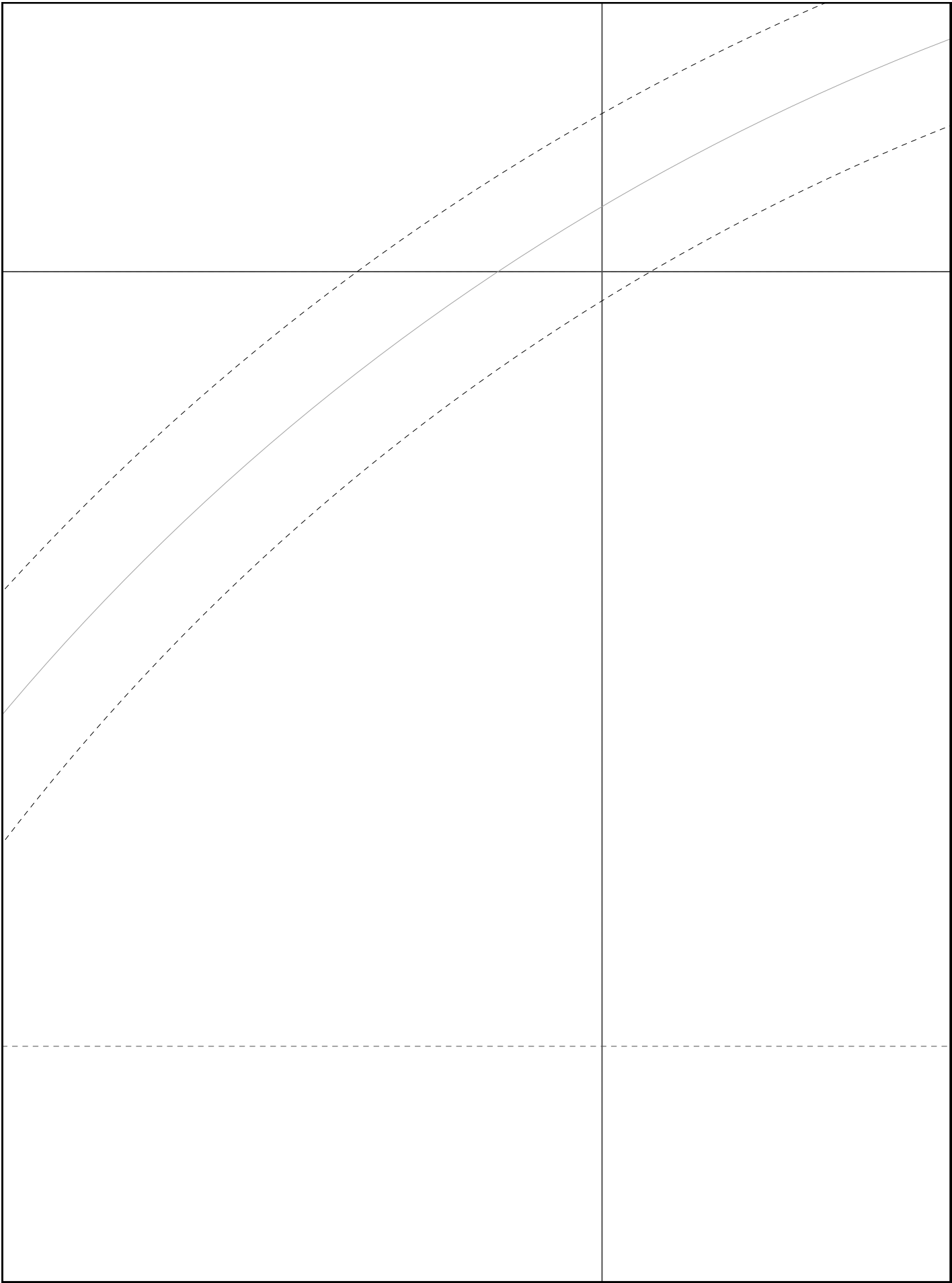



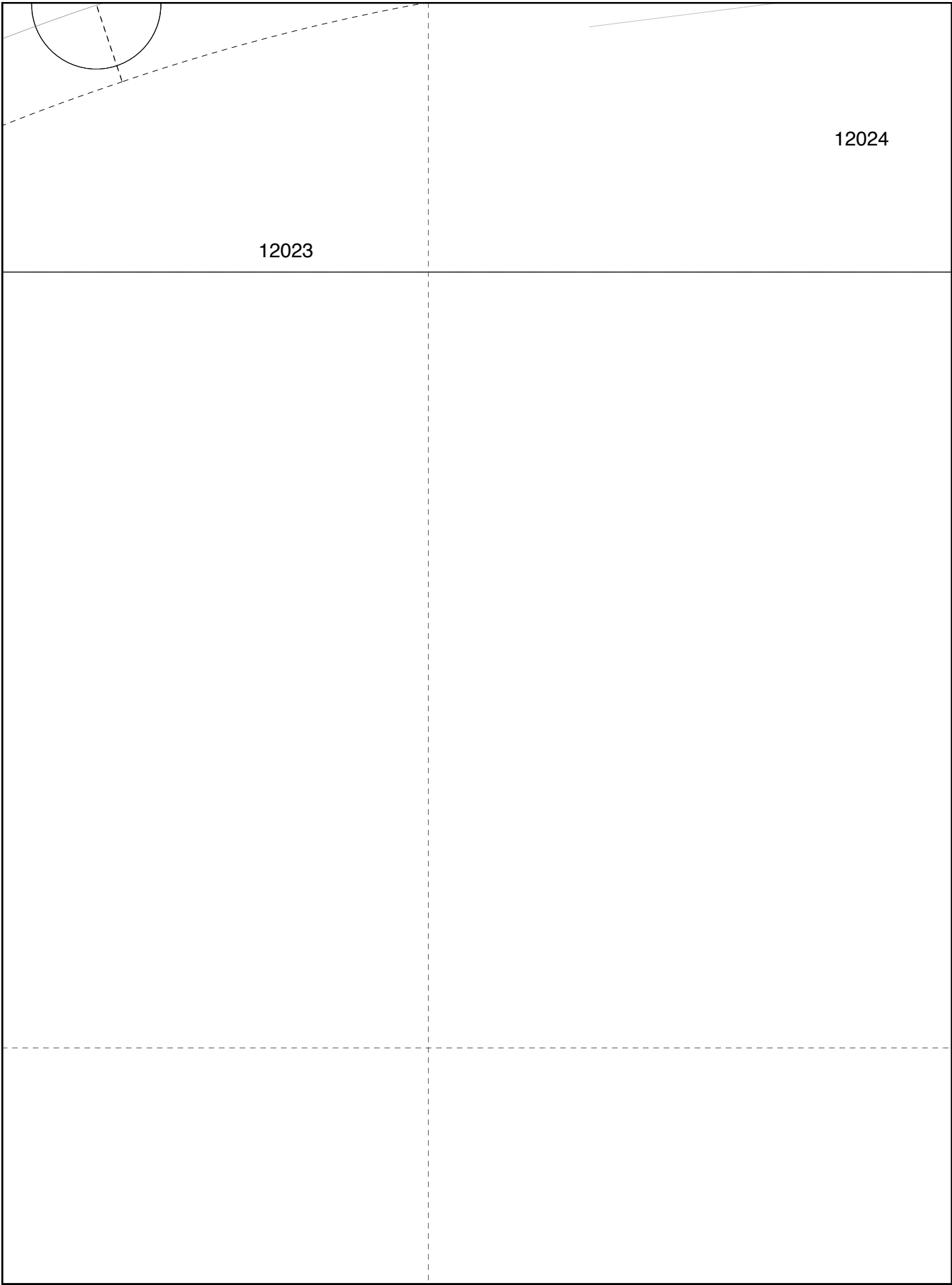

12024

12023

12029

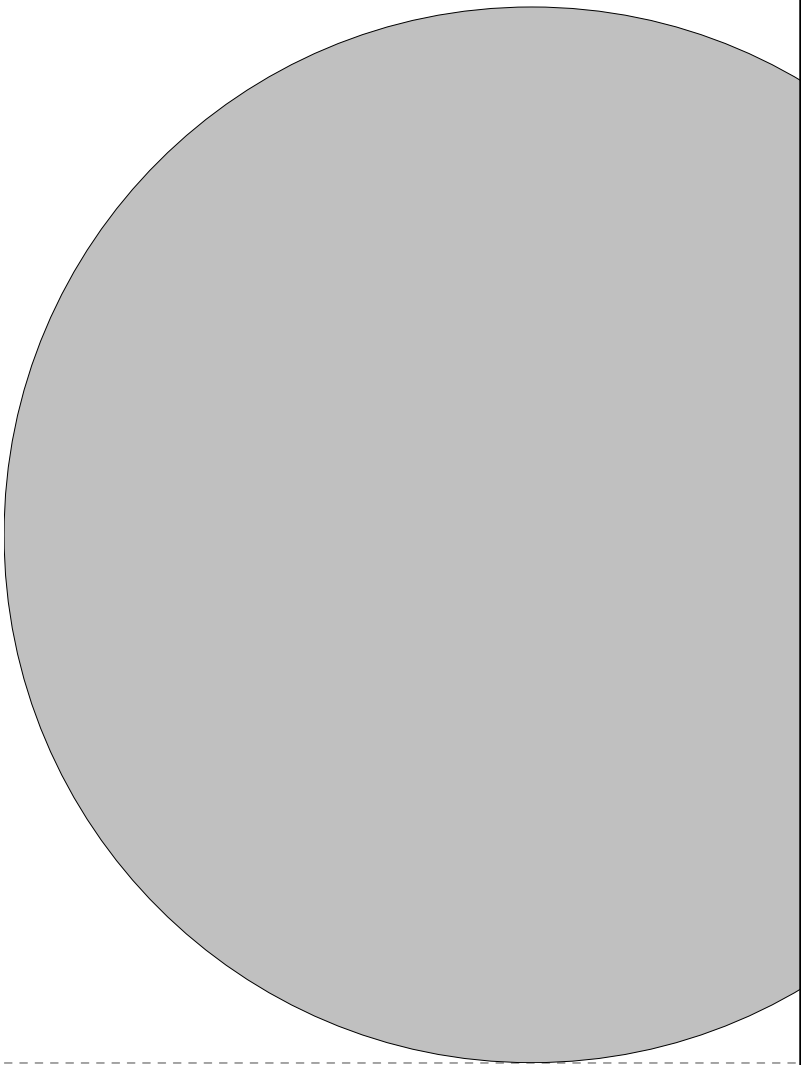

12036

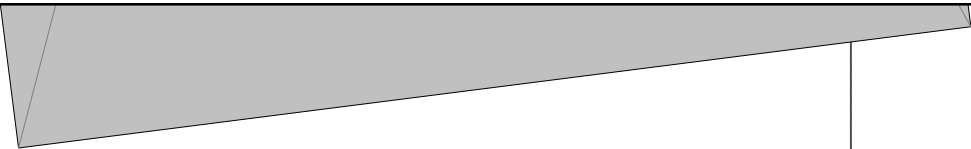
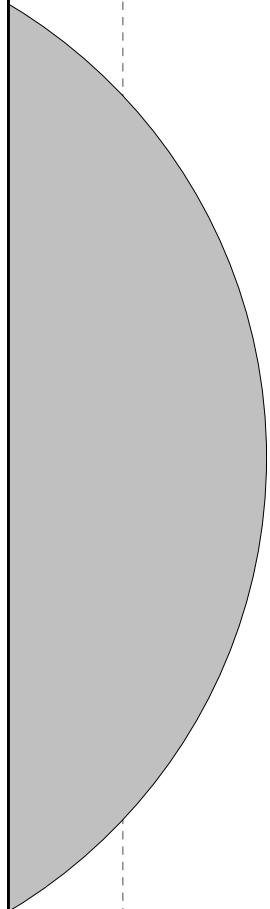

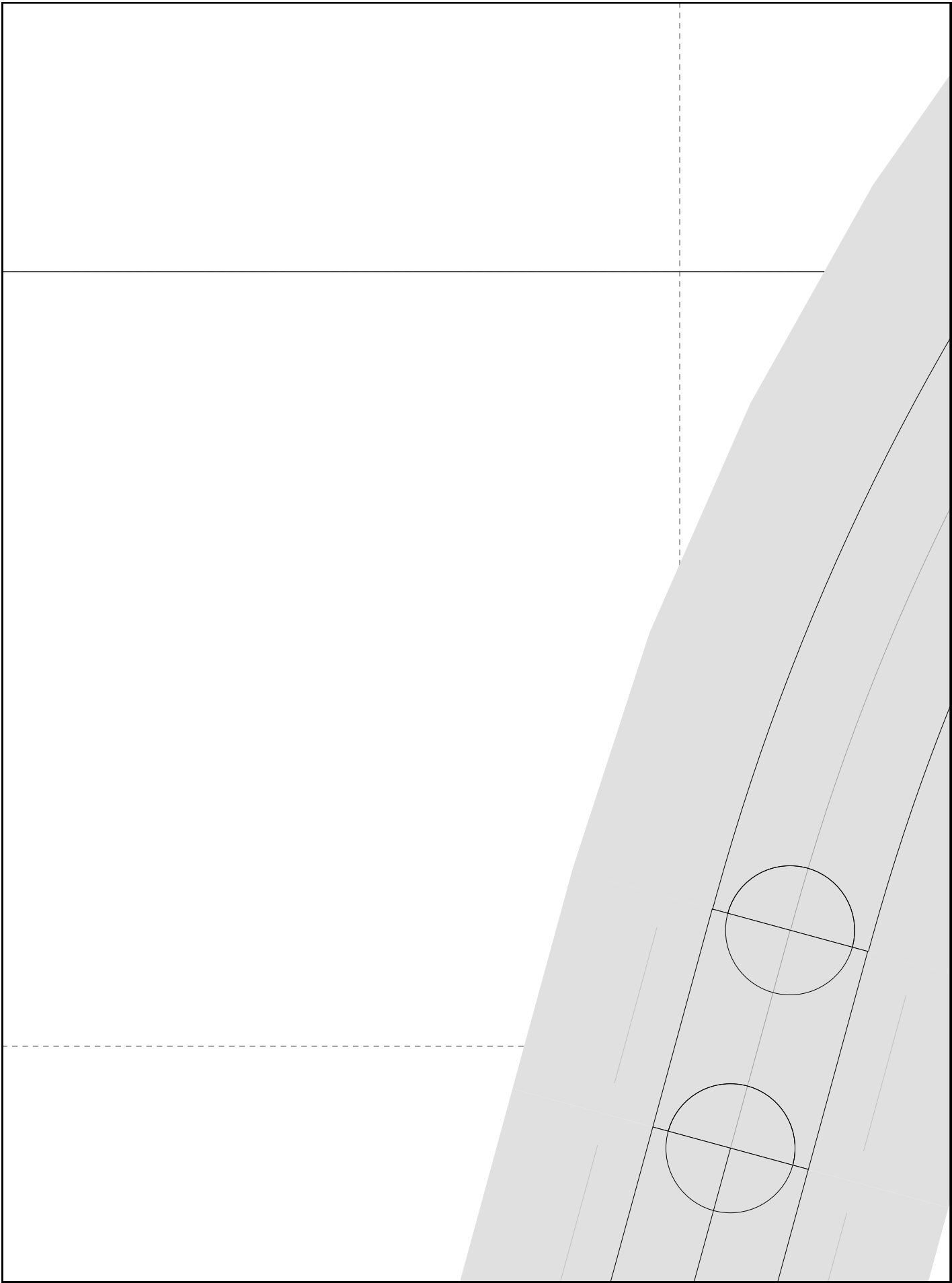

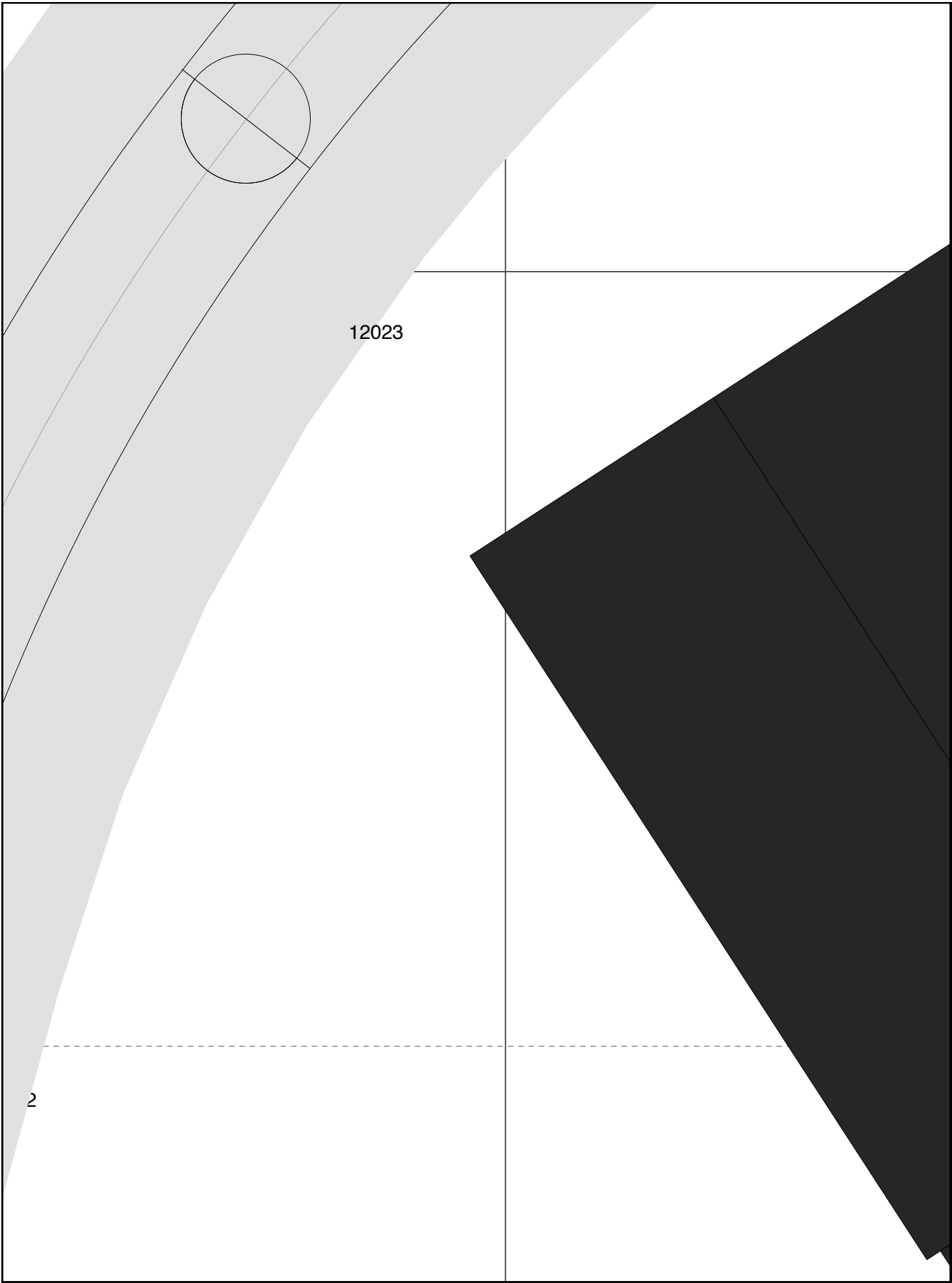

12023

2

12045

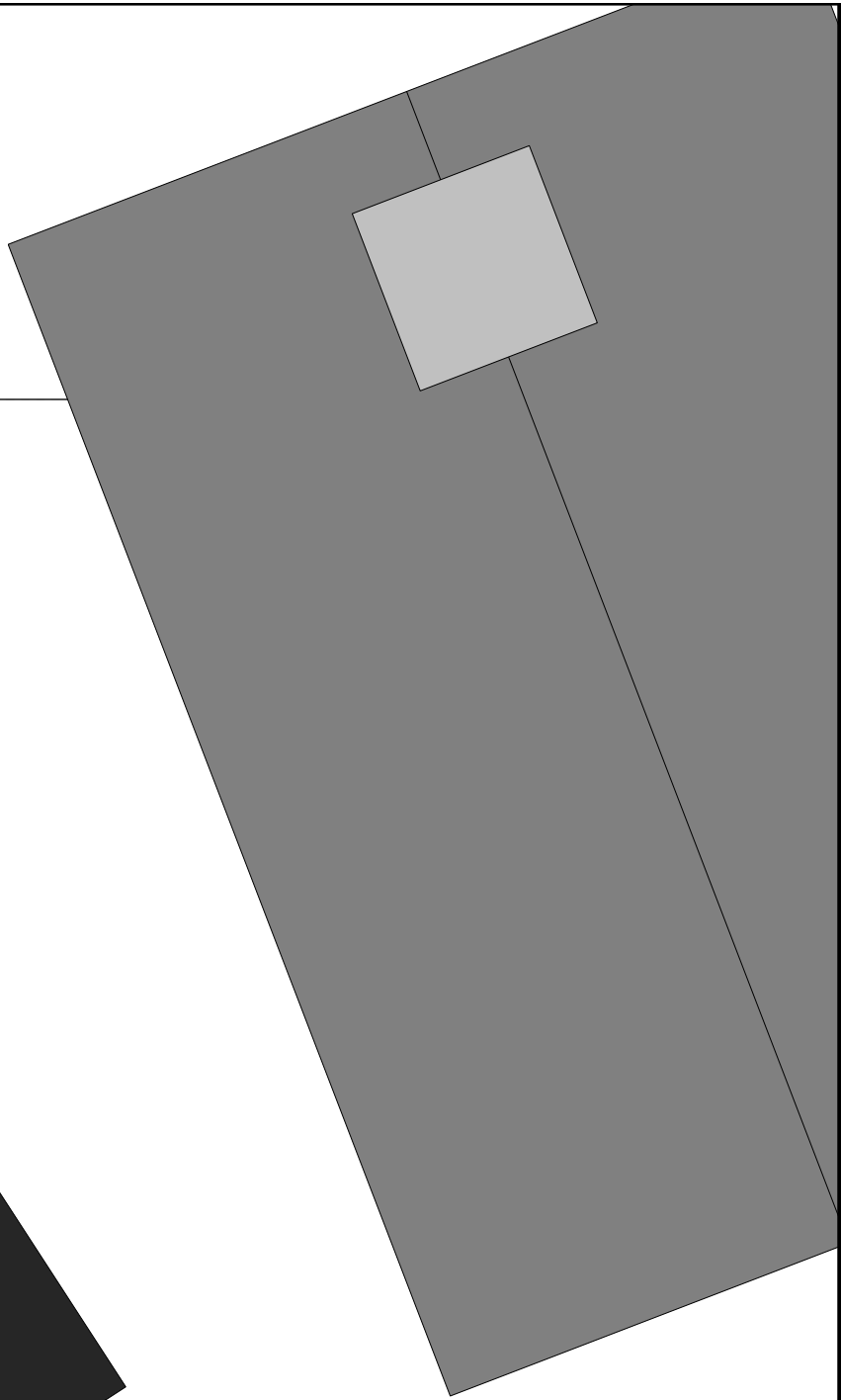
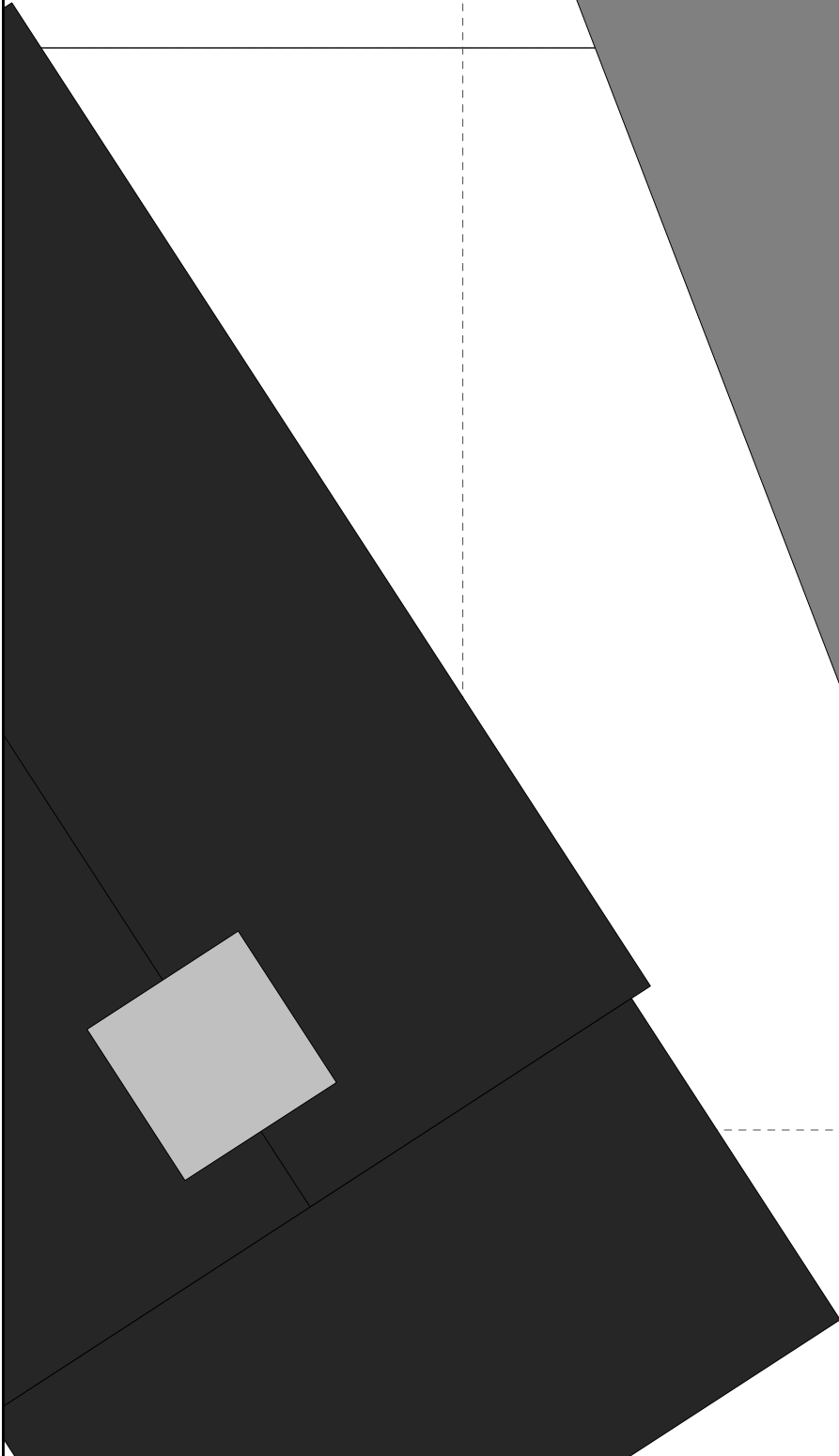

9001

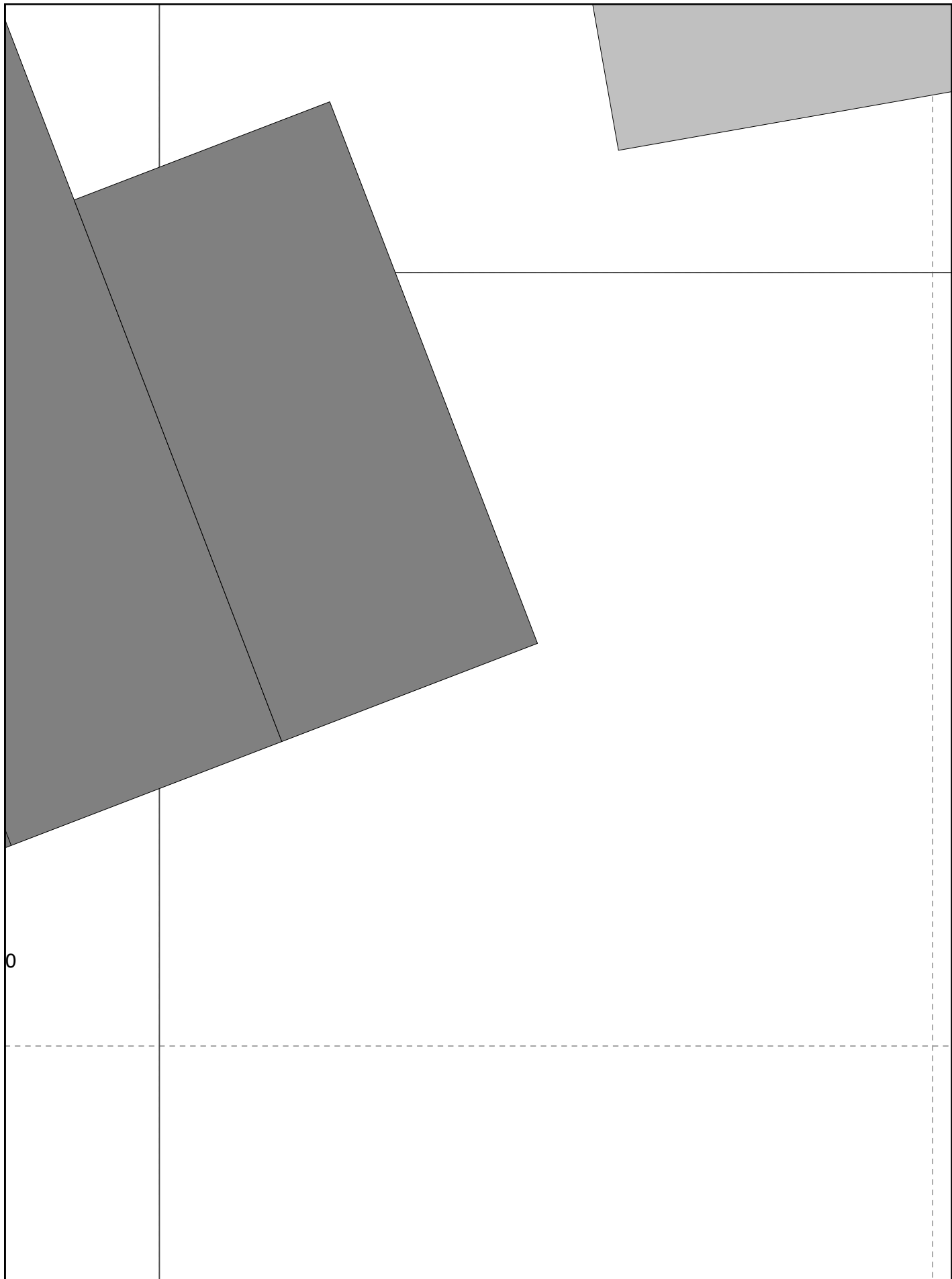



1625



12015

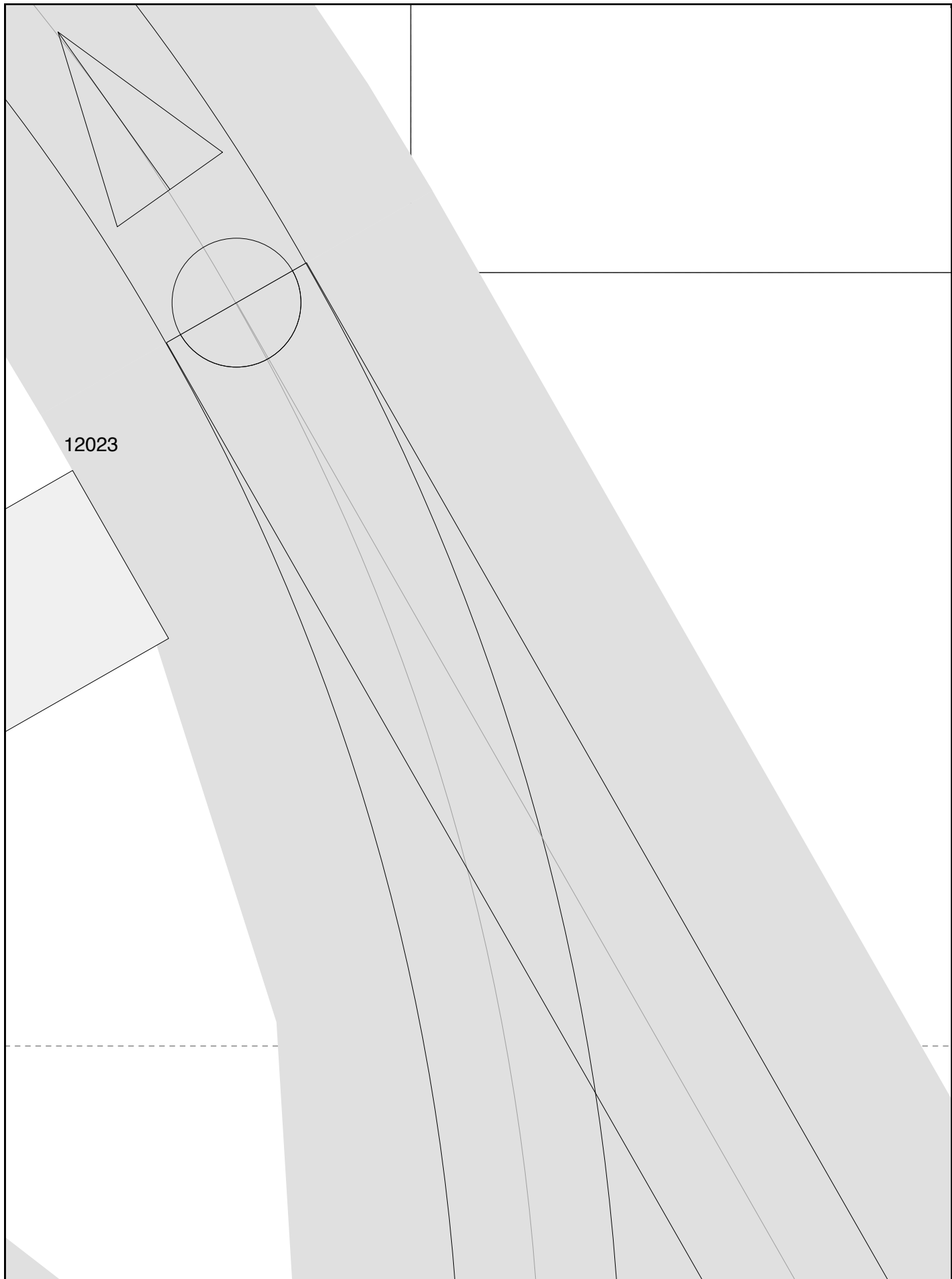

12023

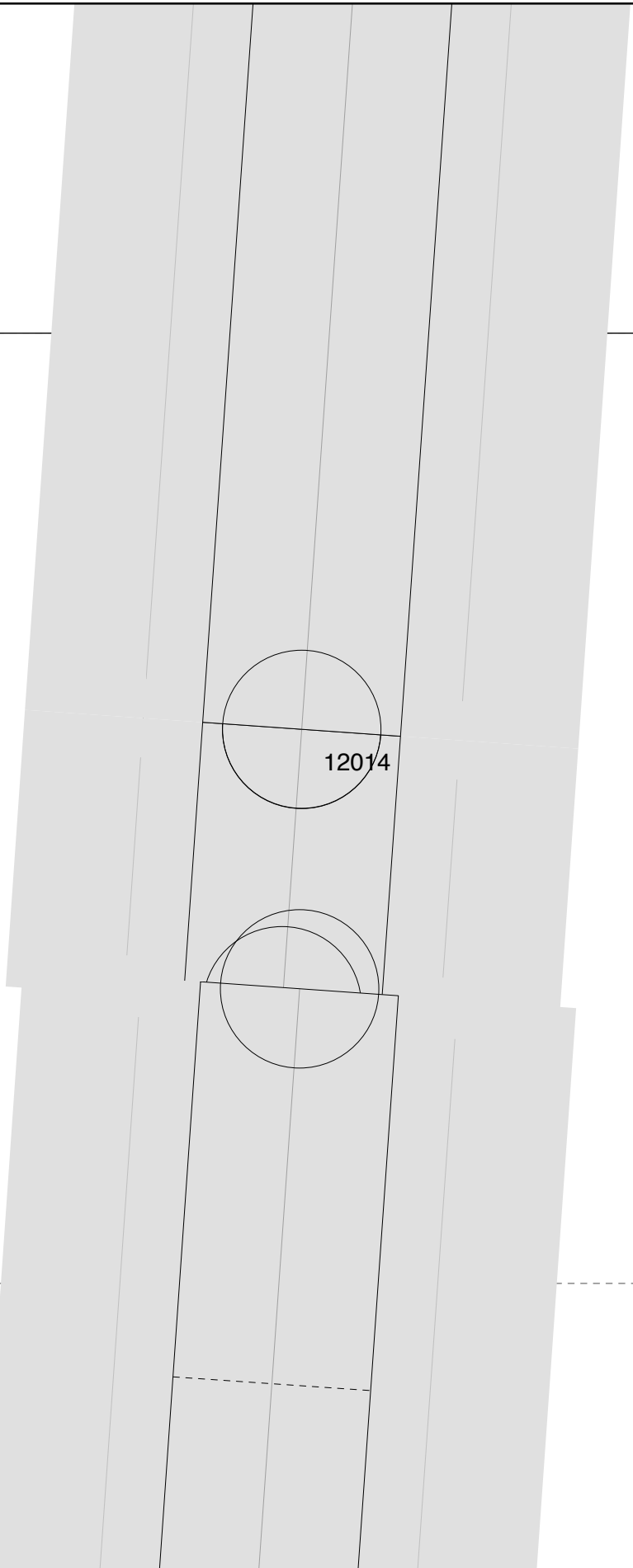

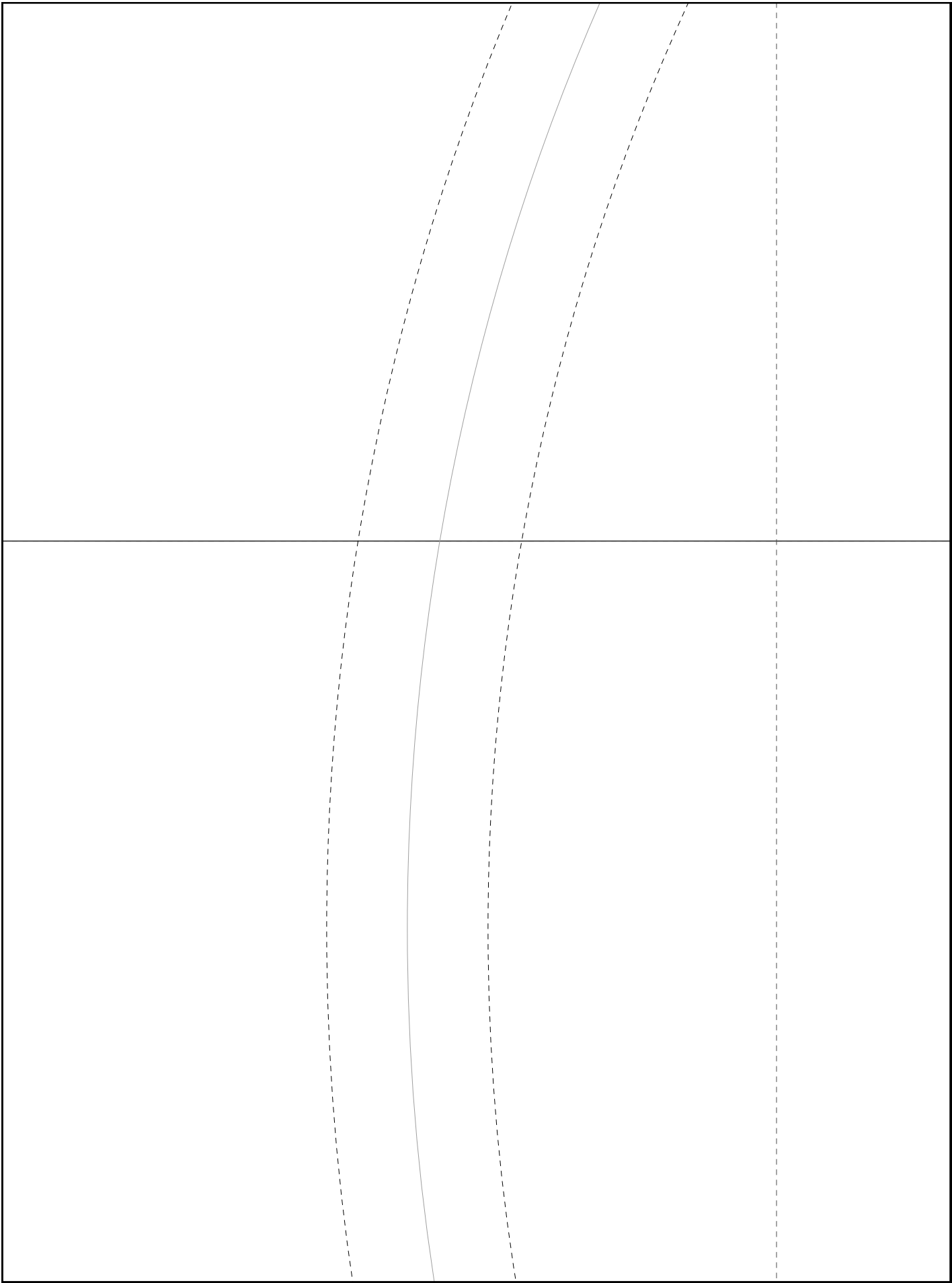

12015

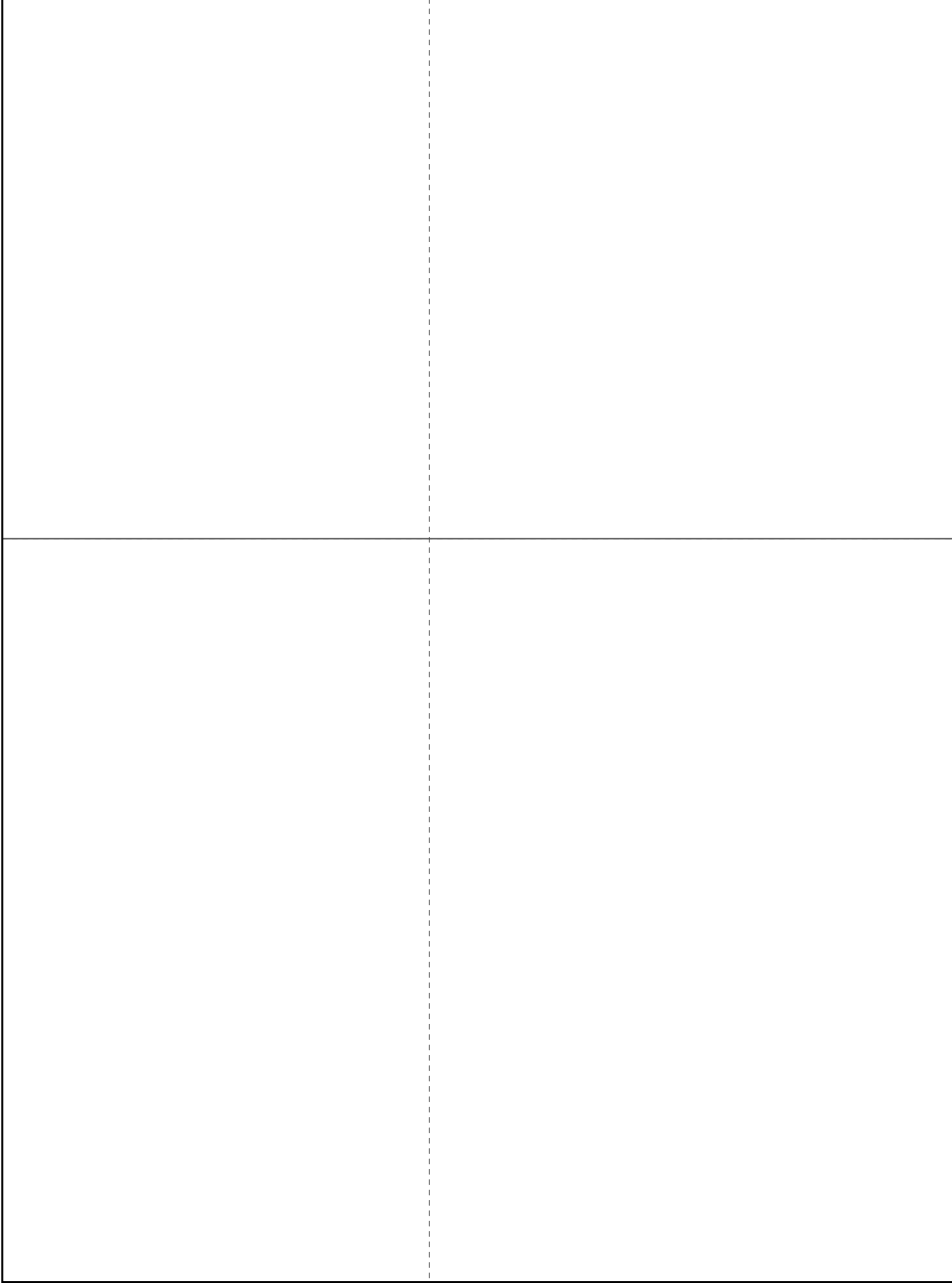

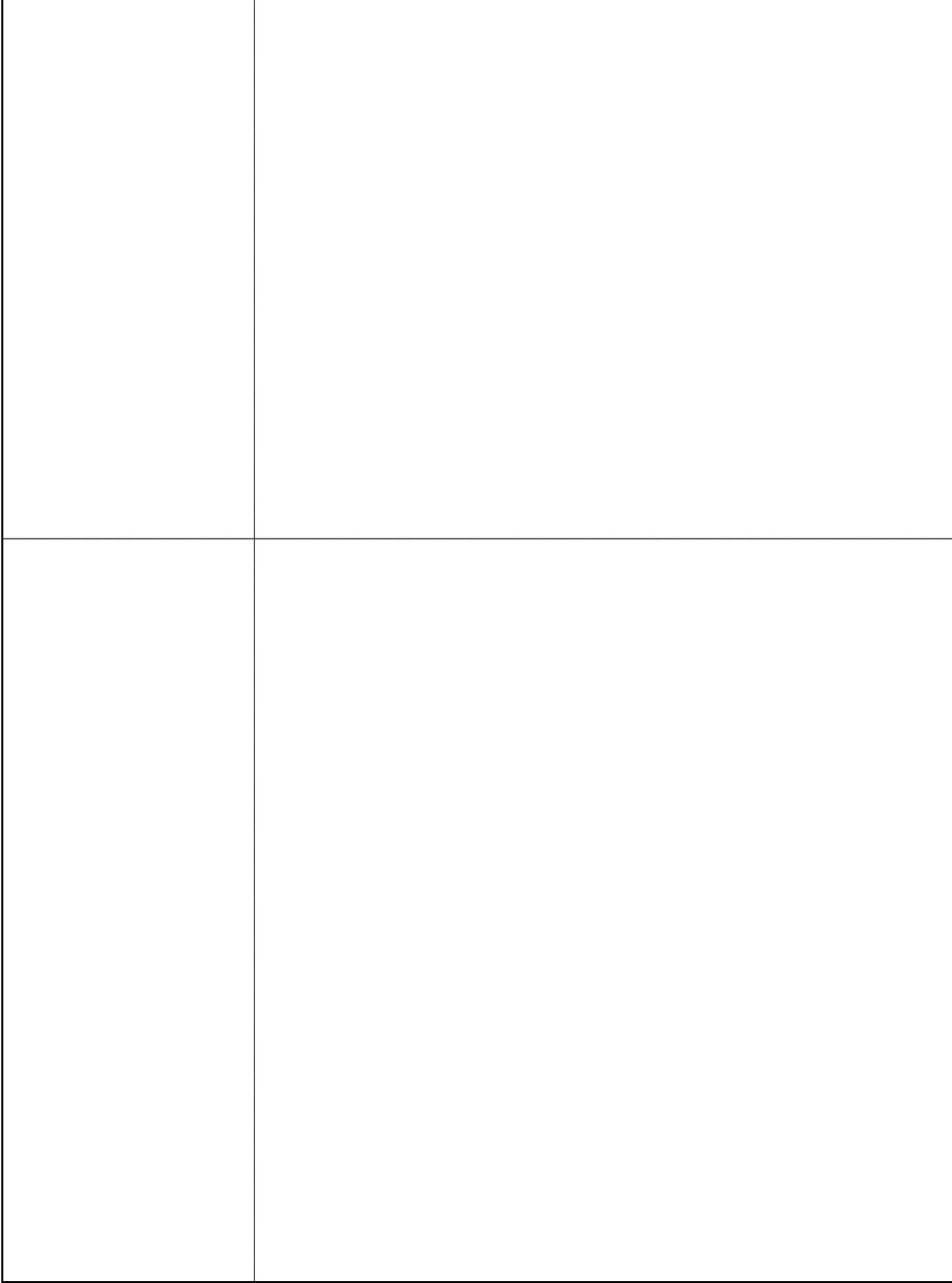

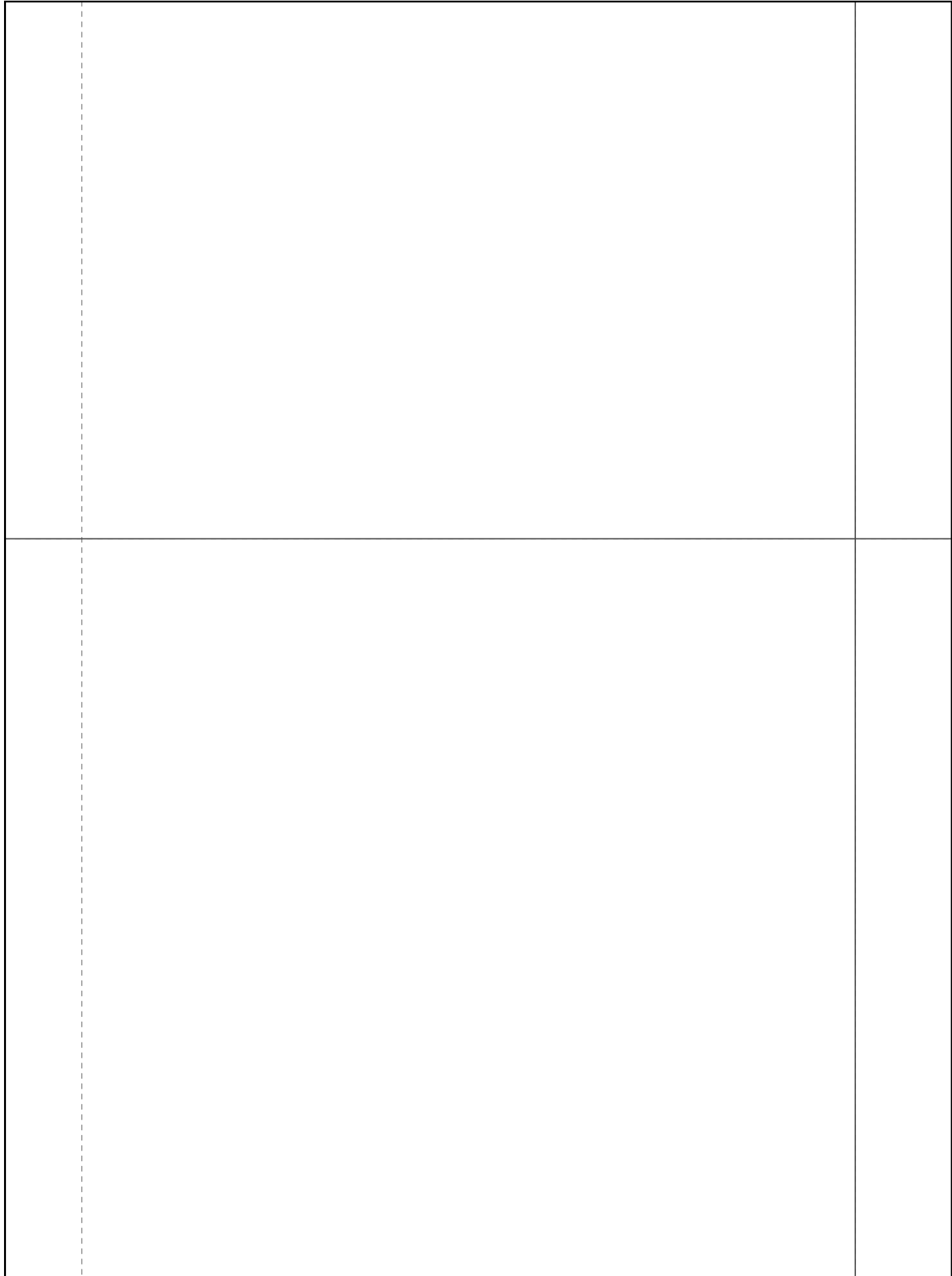



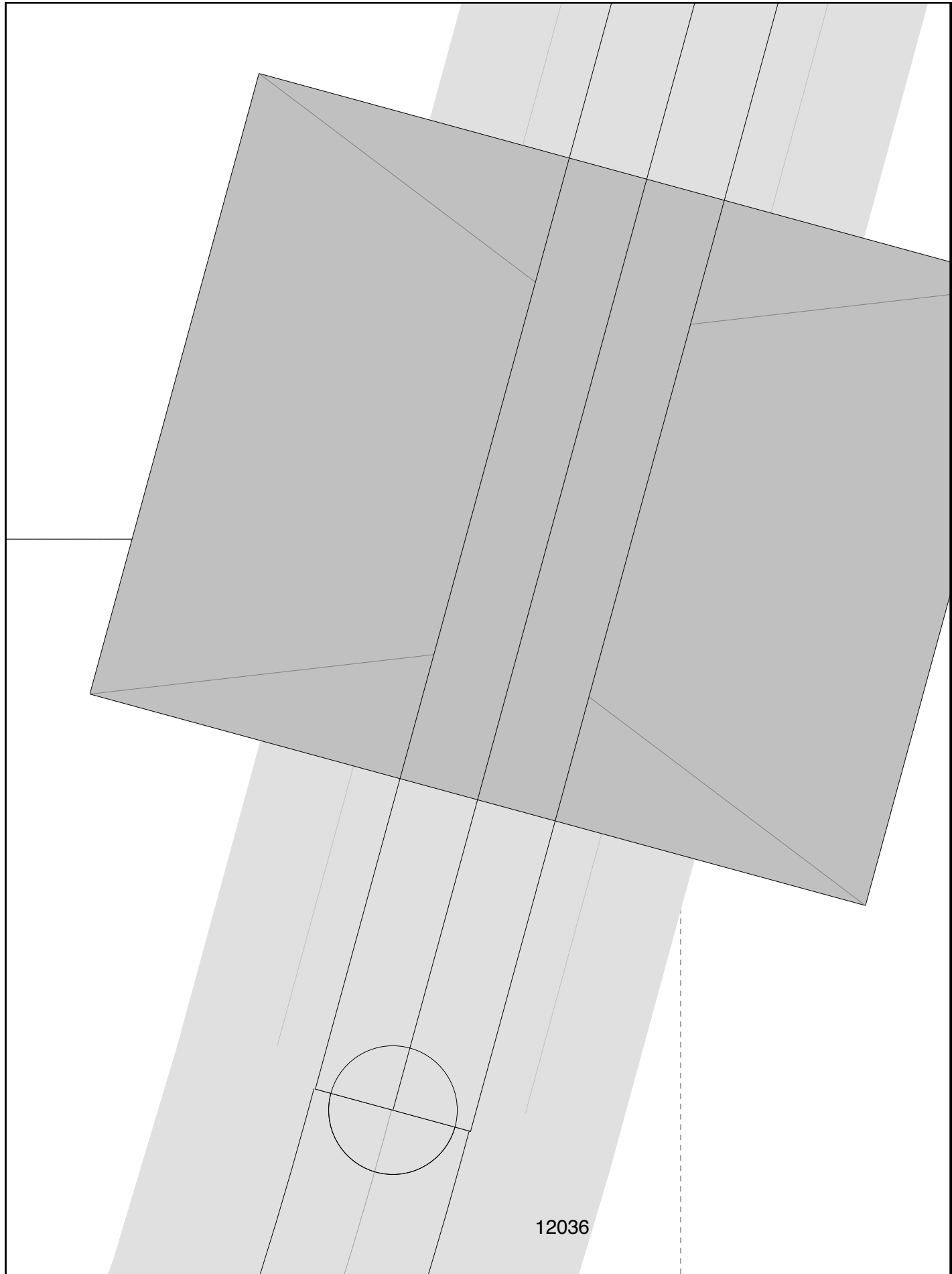

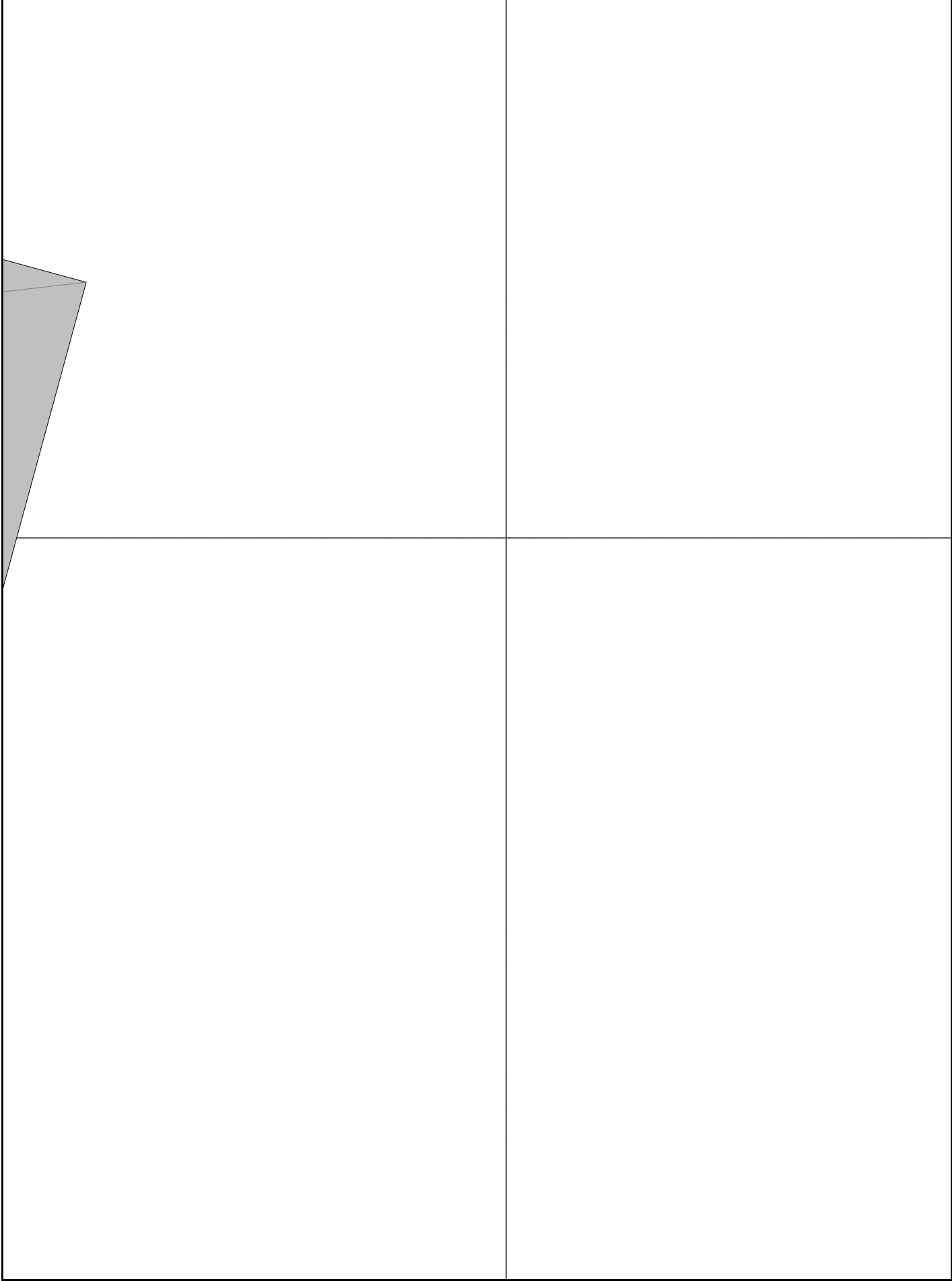

12036





90008

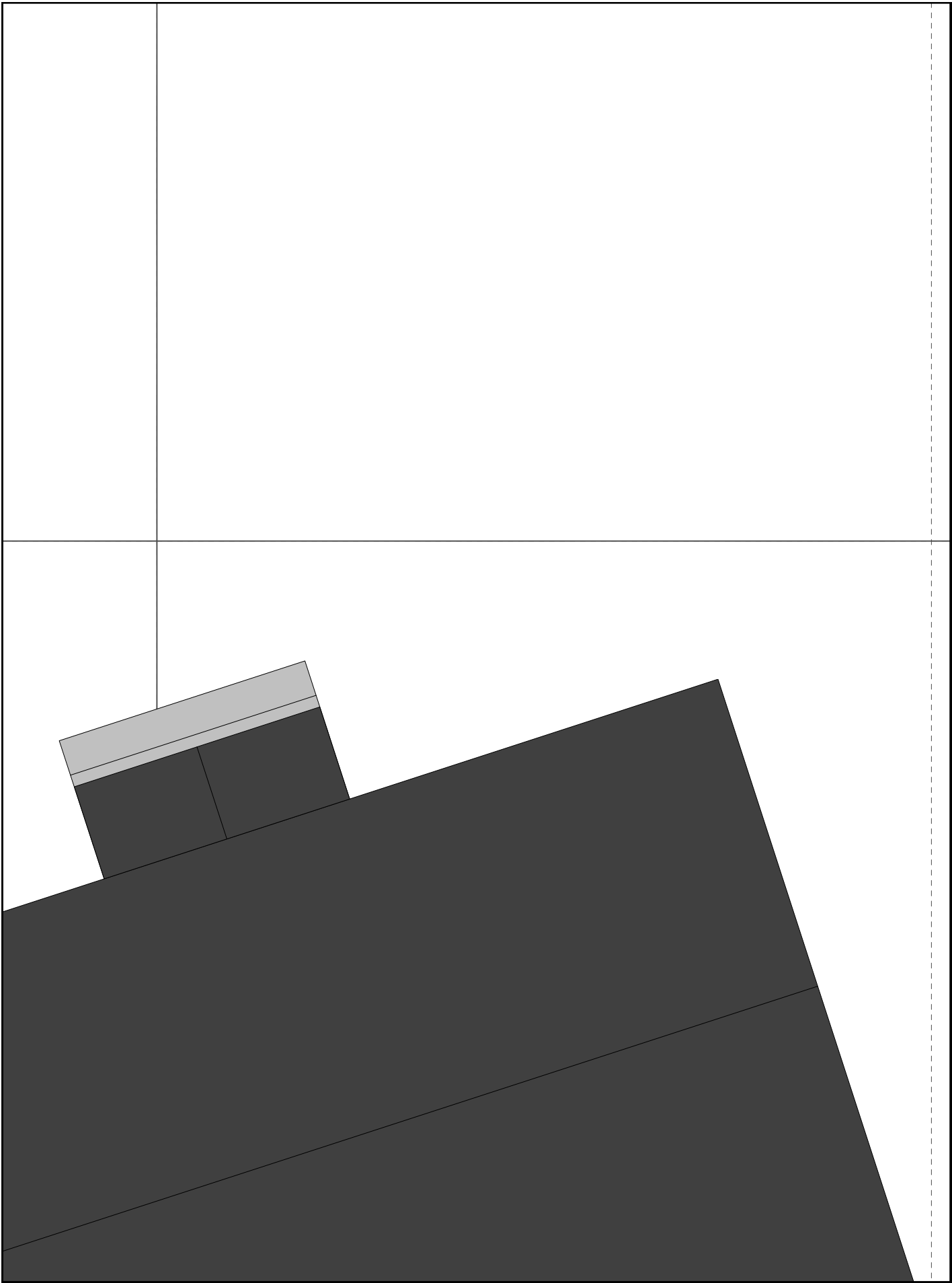

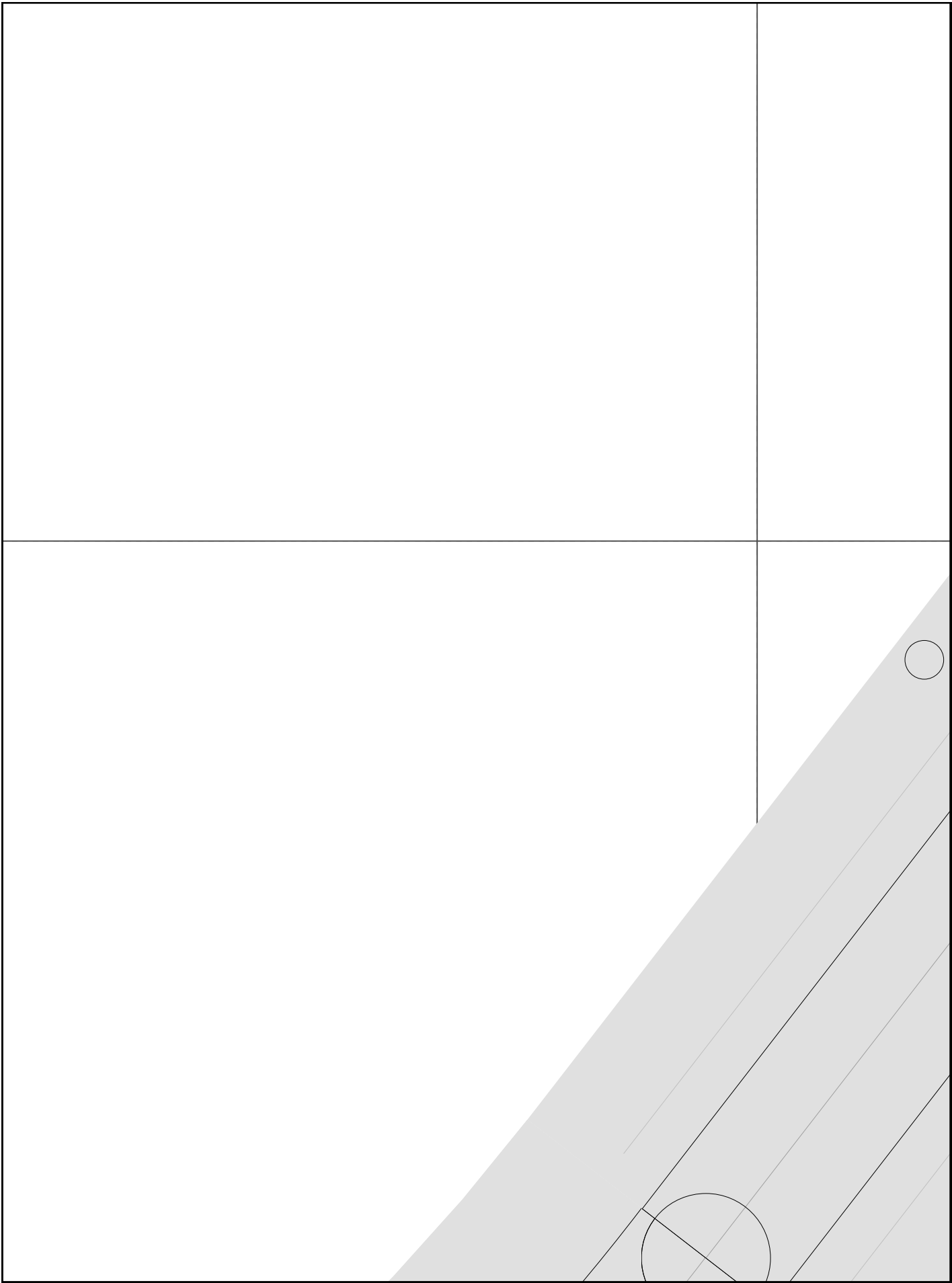

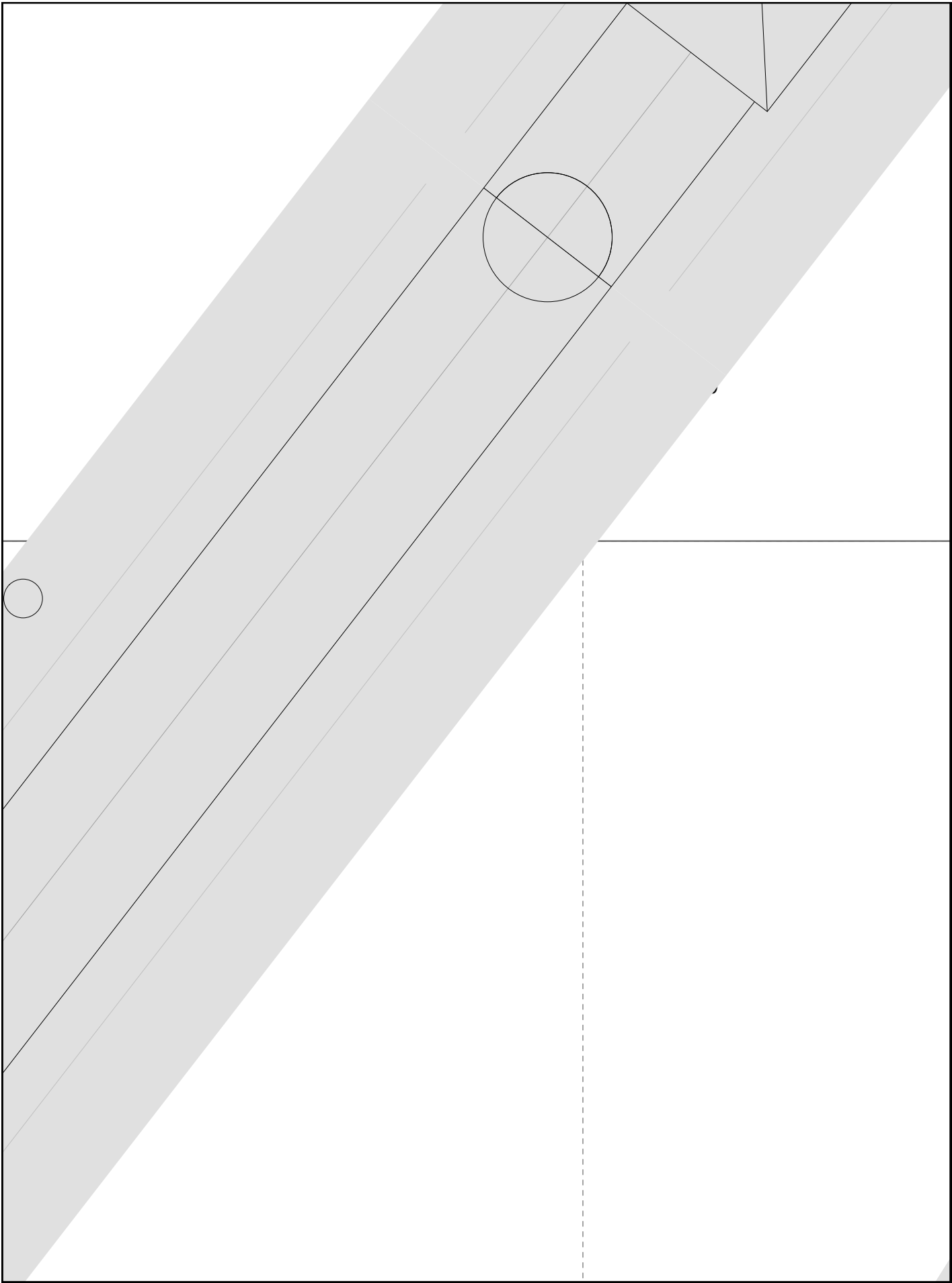

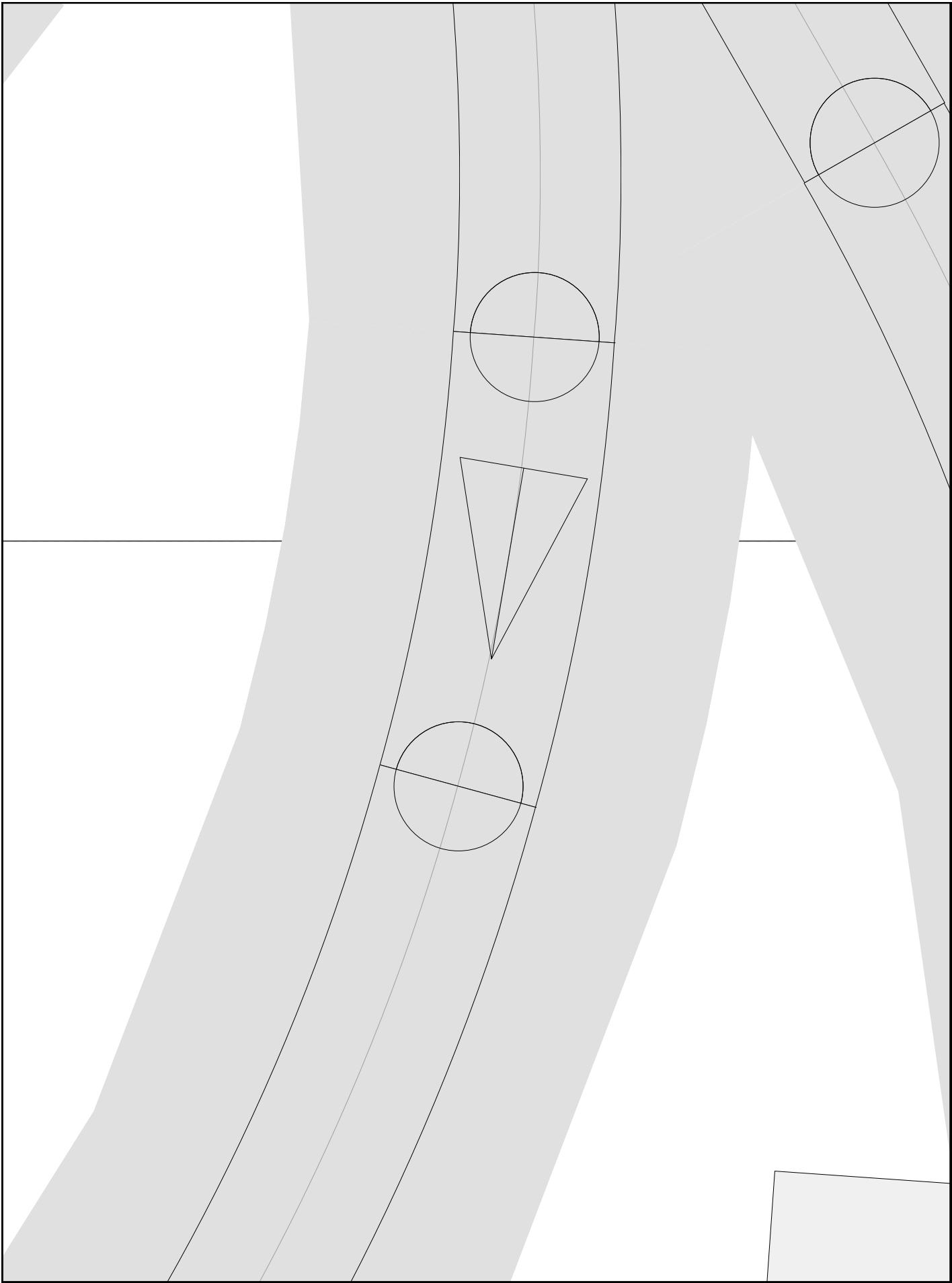

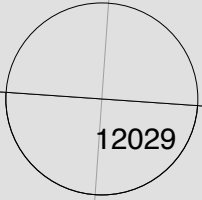

12029



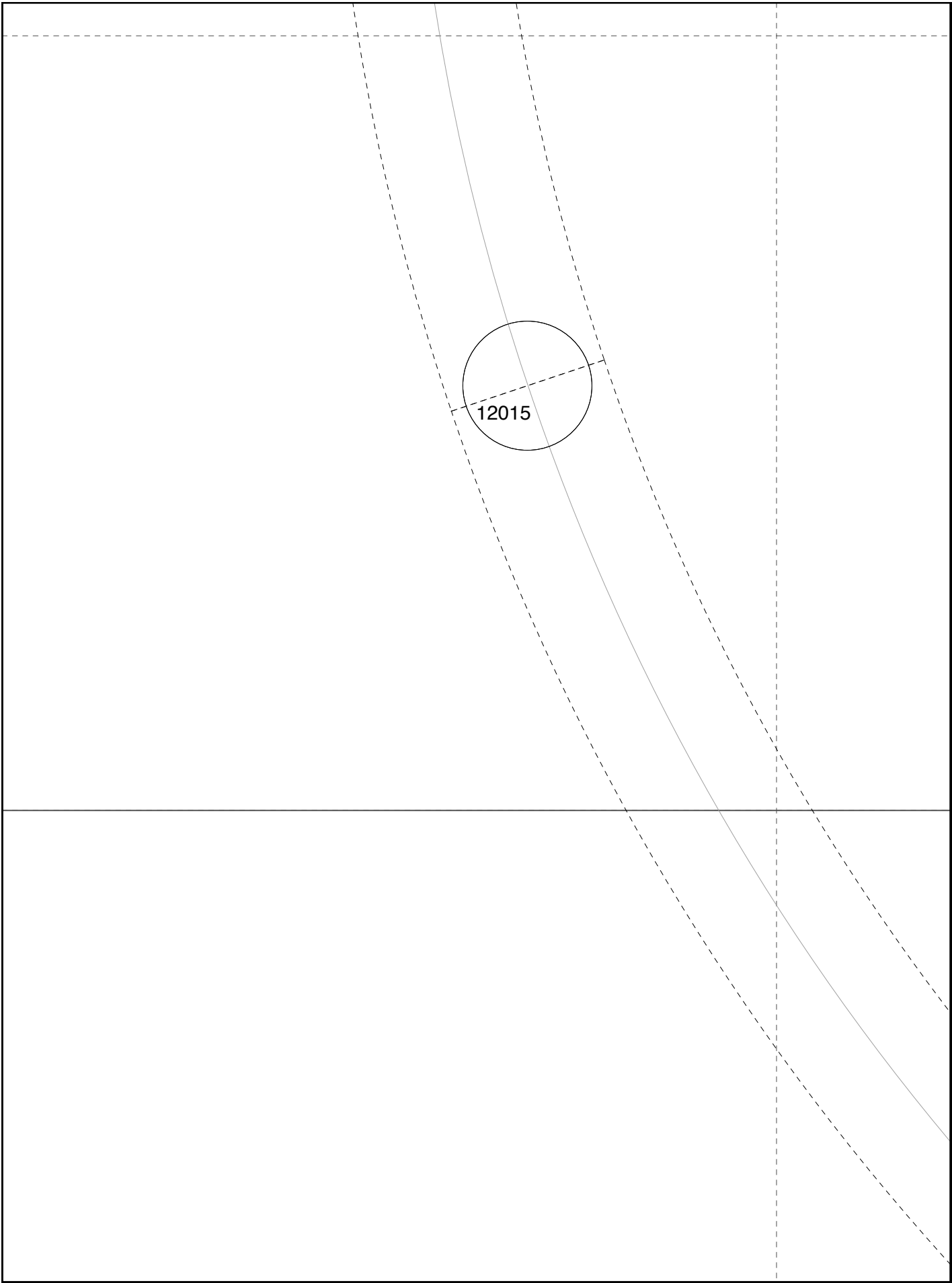

12015

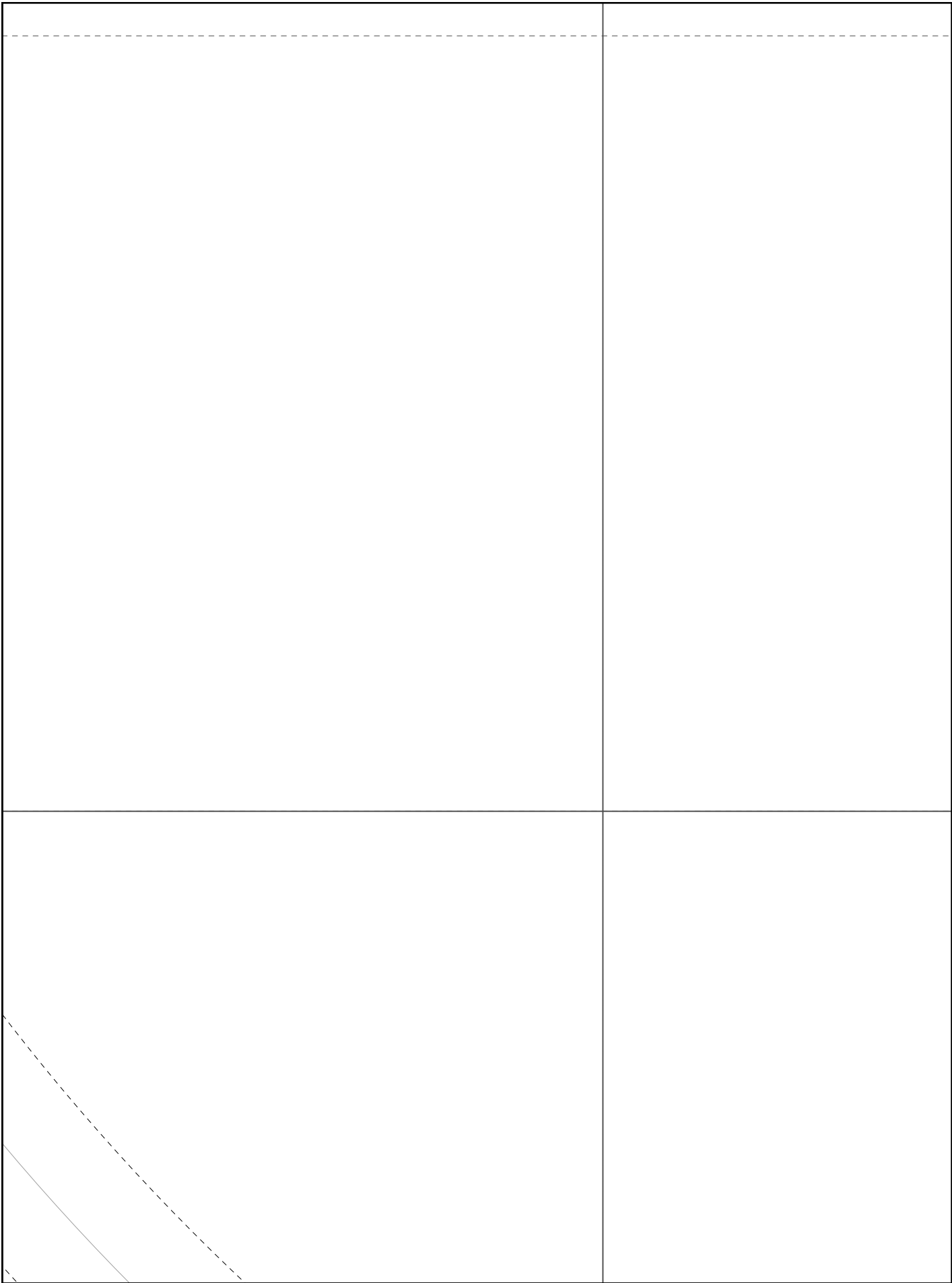

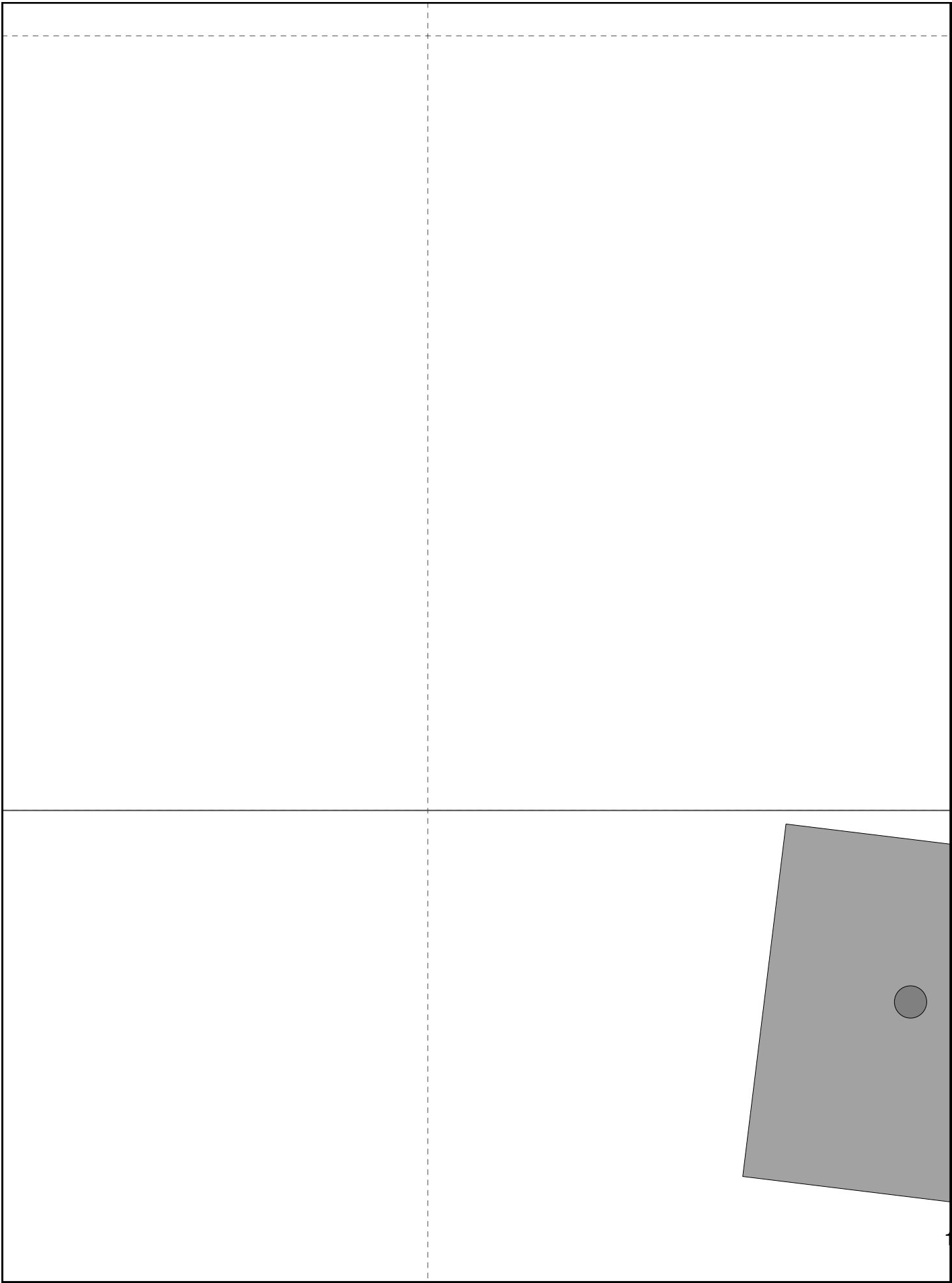

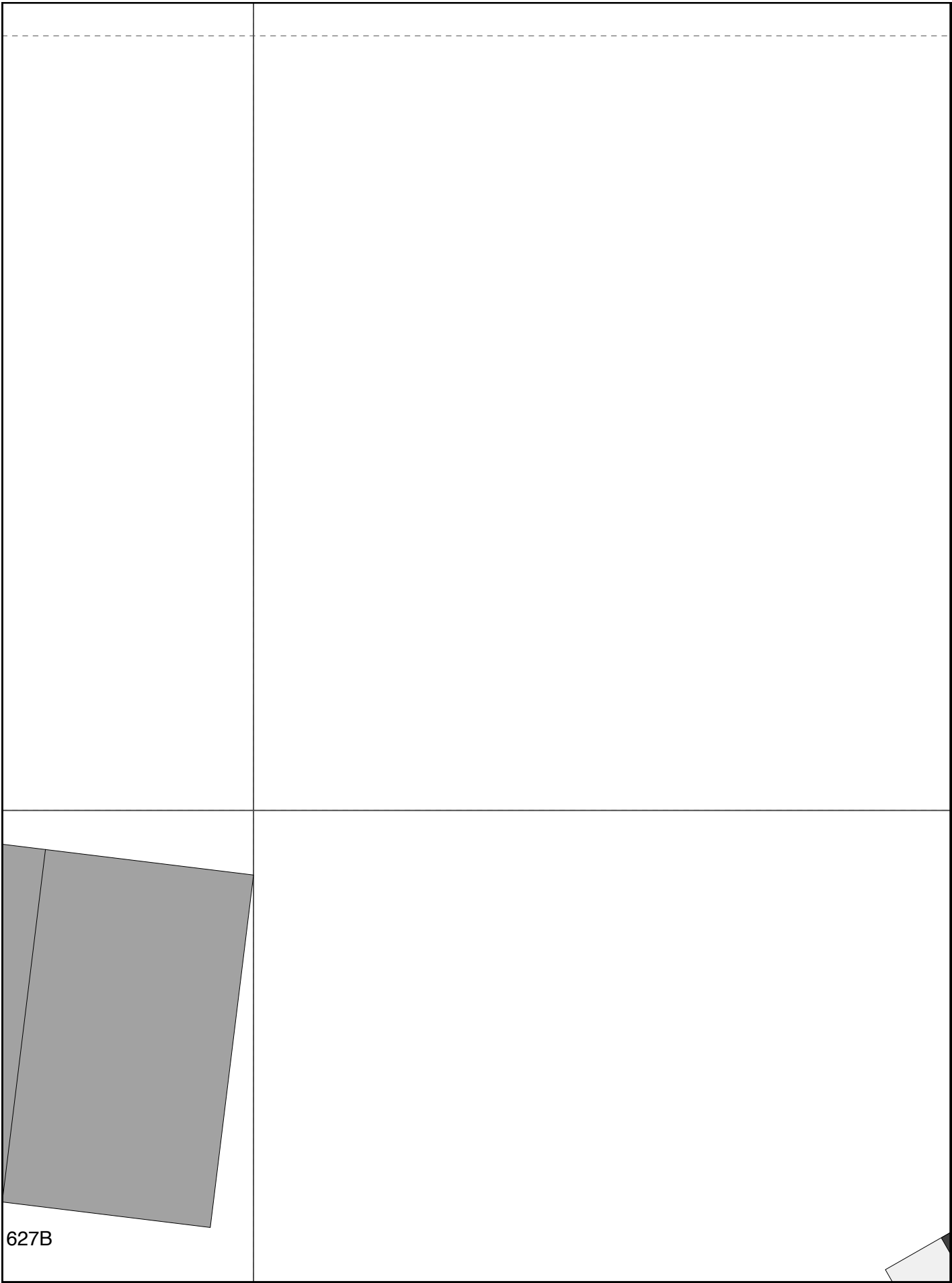

627B

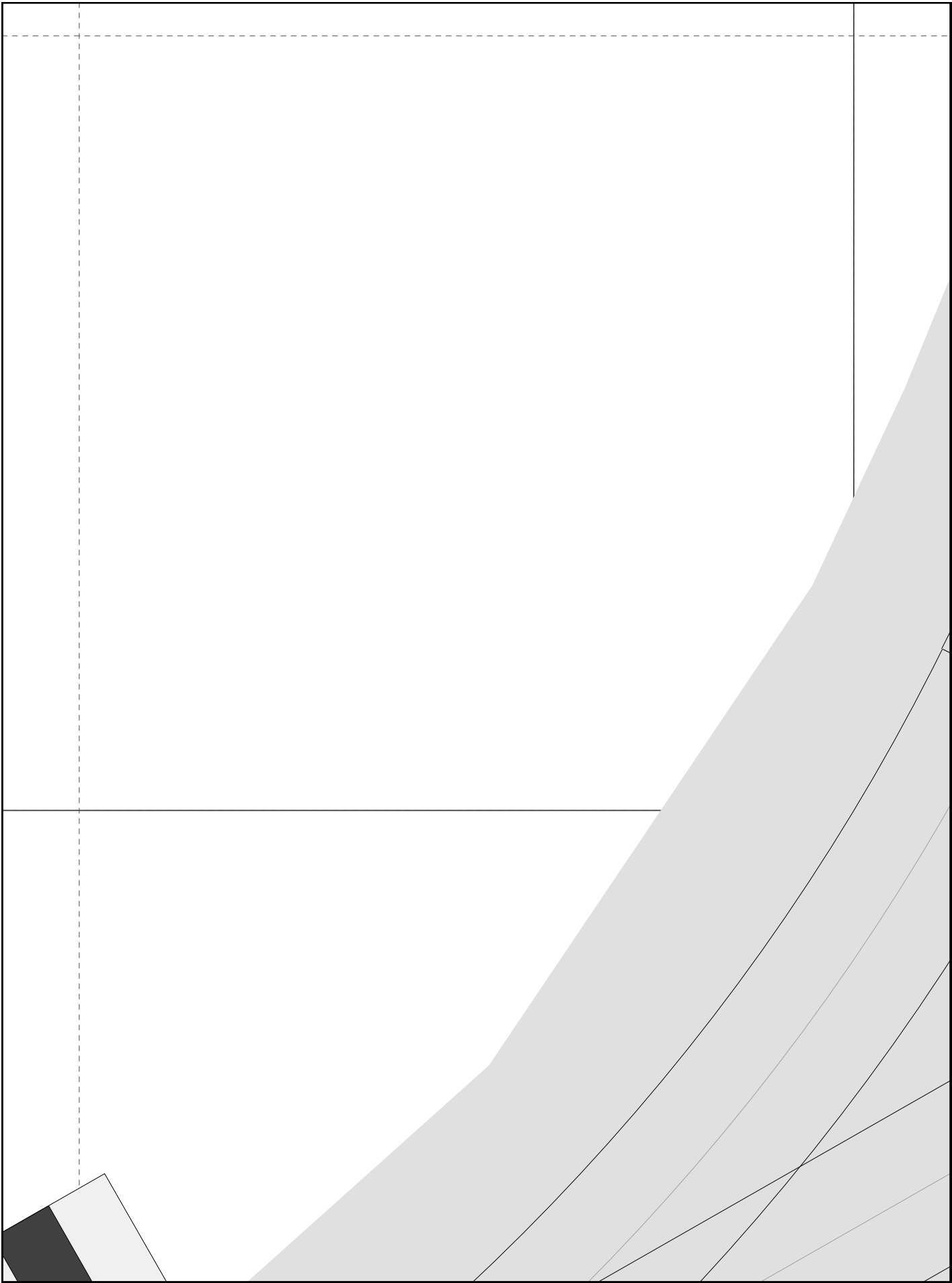

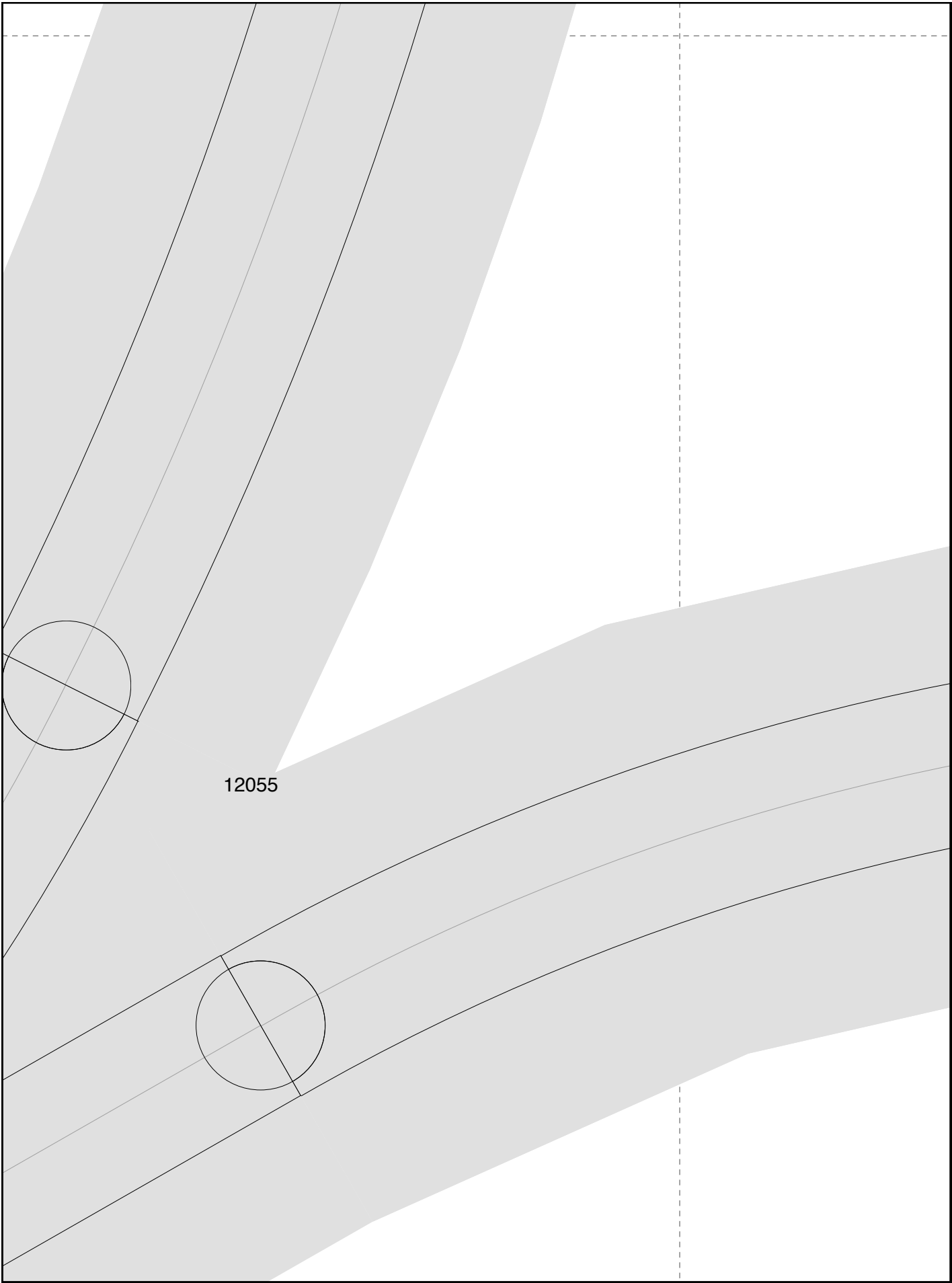

12055

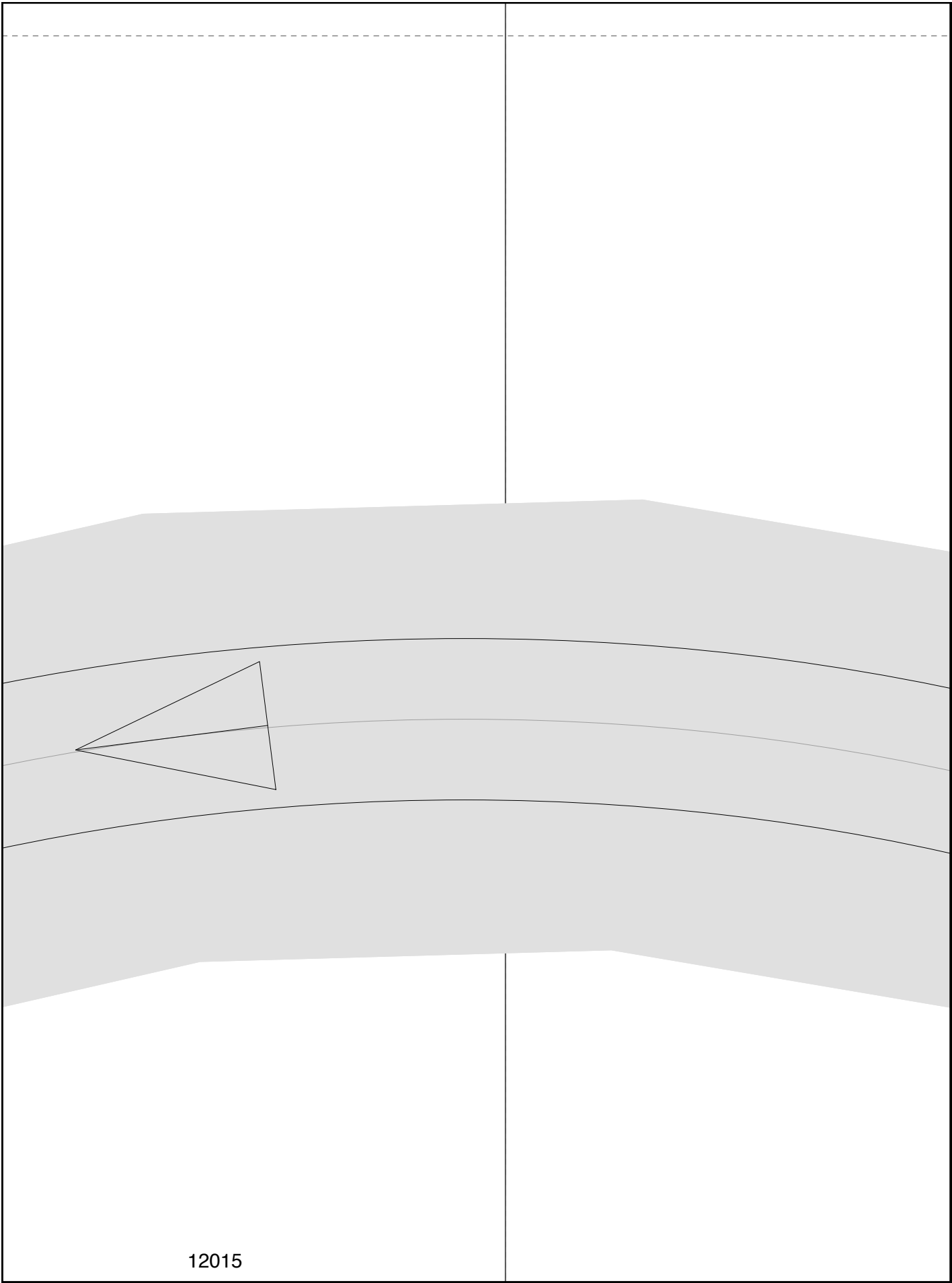

12015

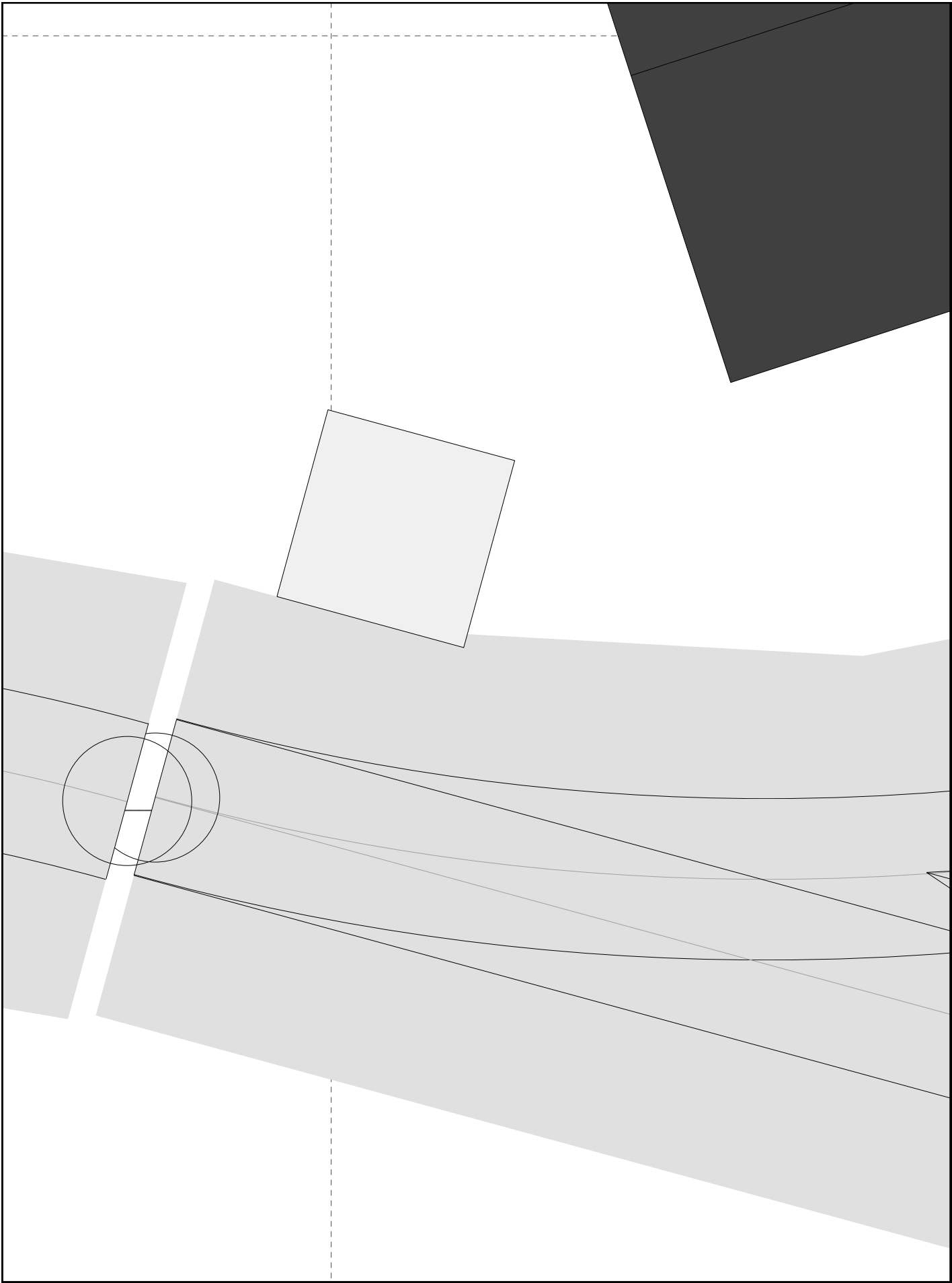



90037

1202

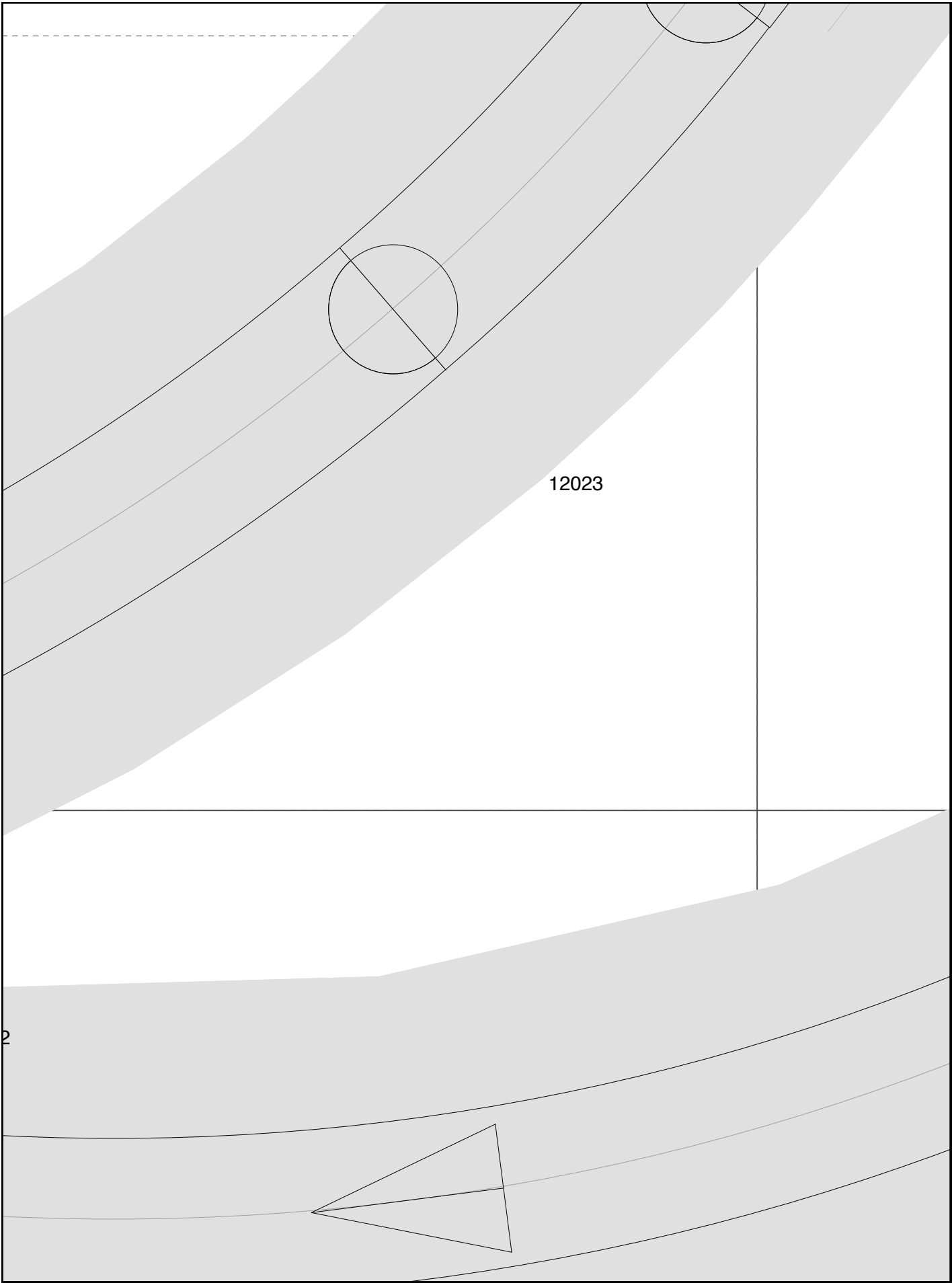

12023

12016

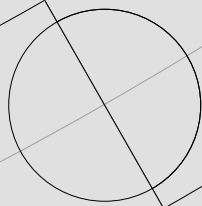

12015

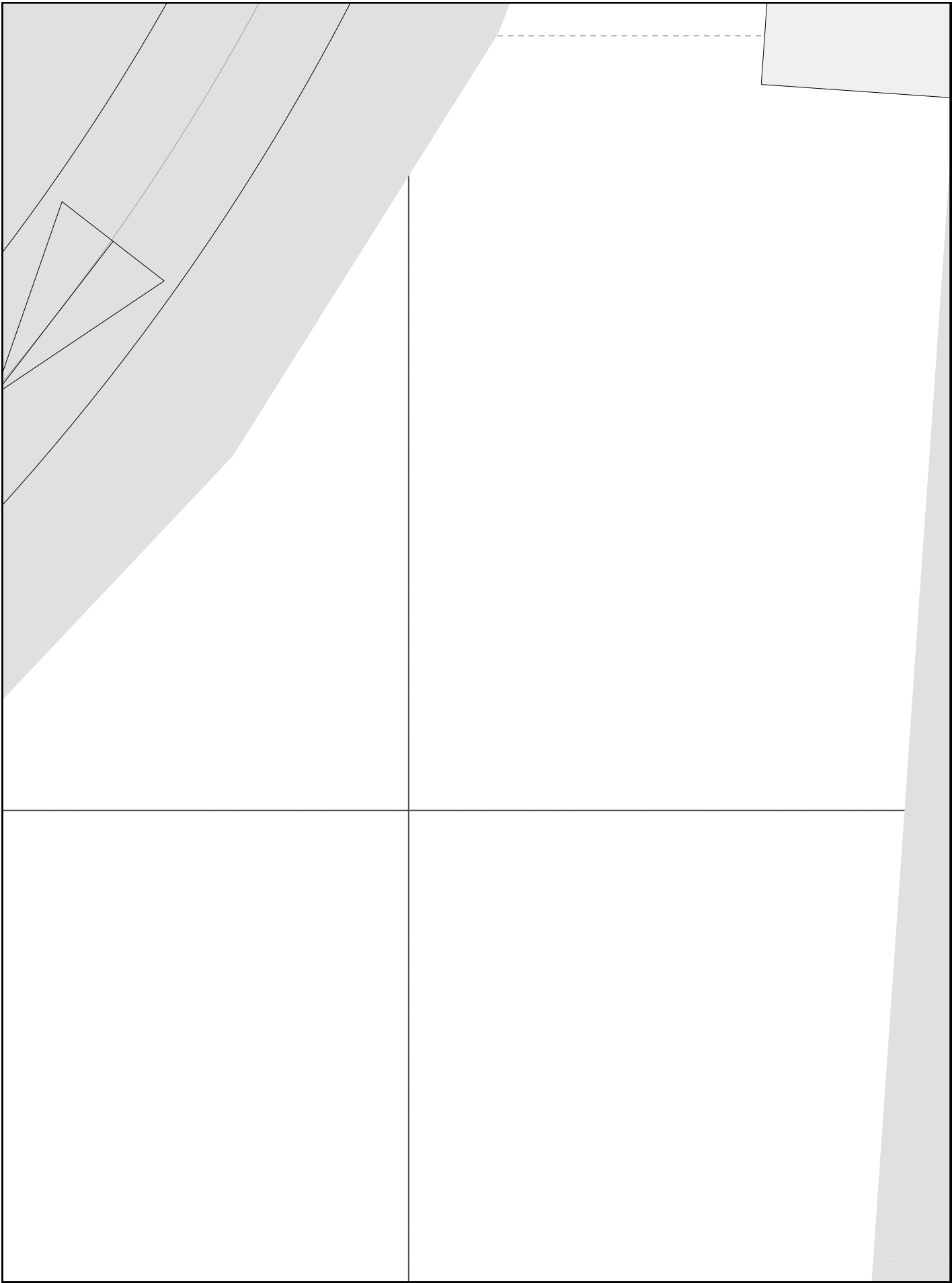

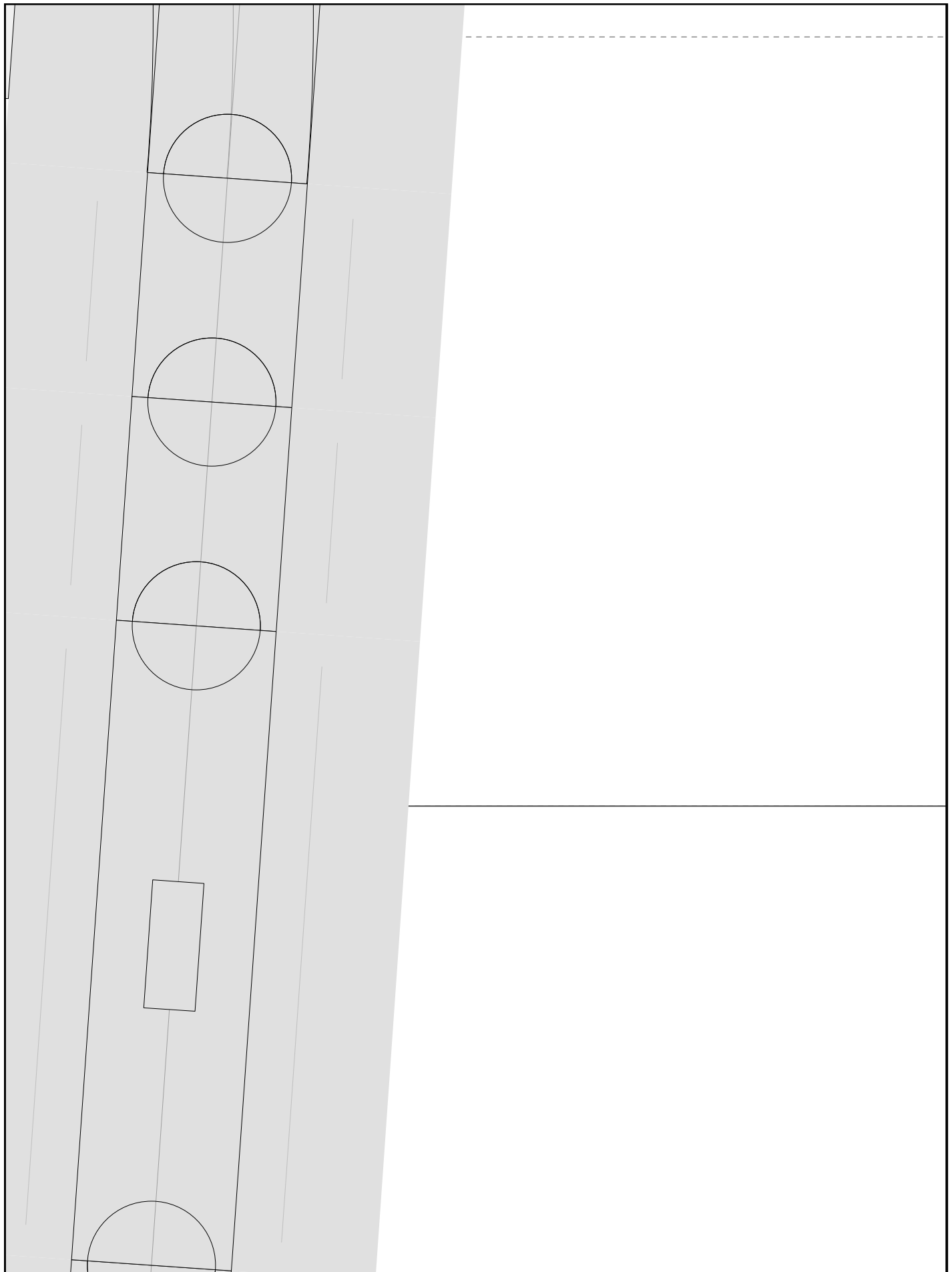

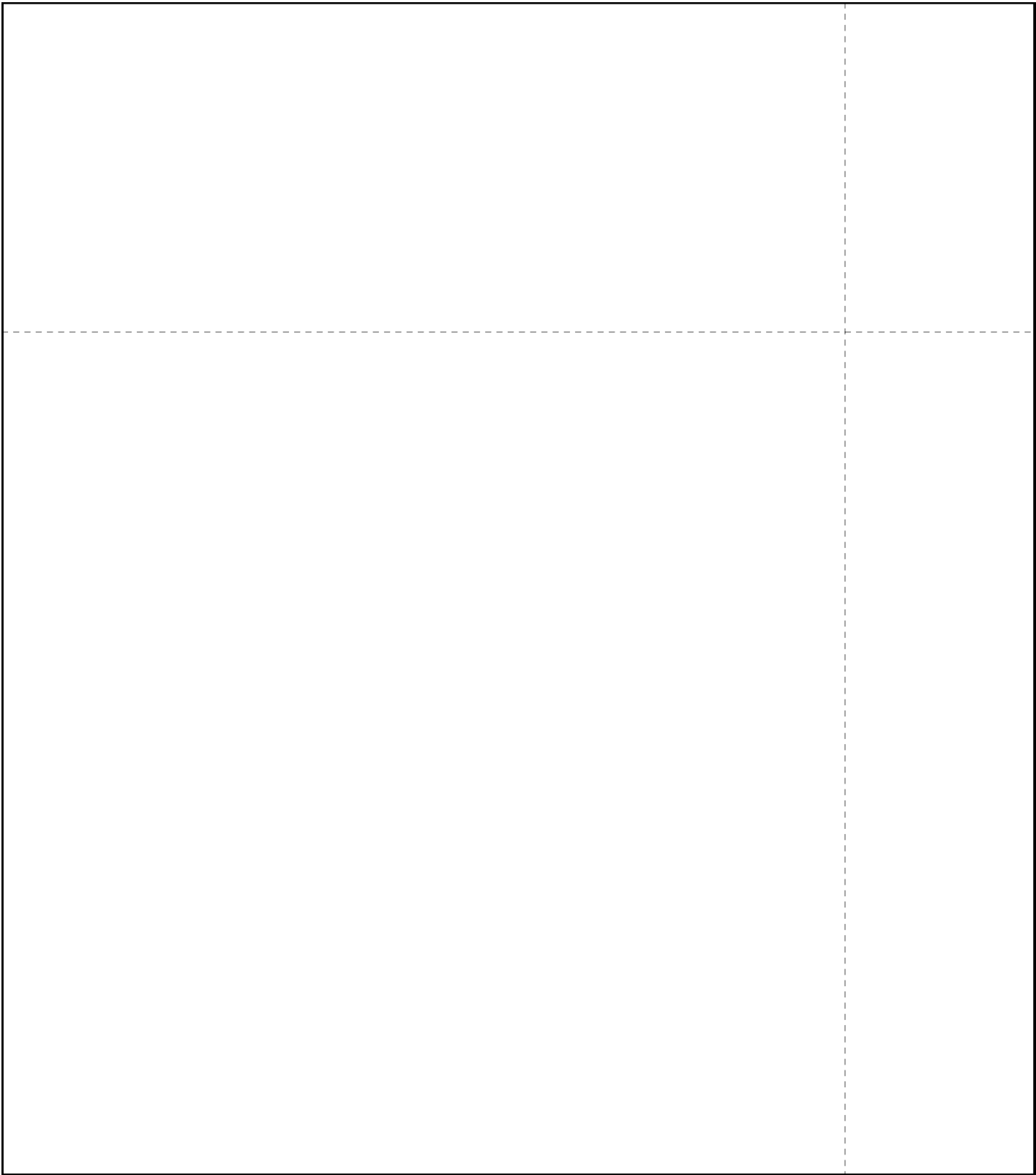

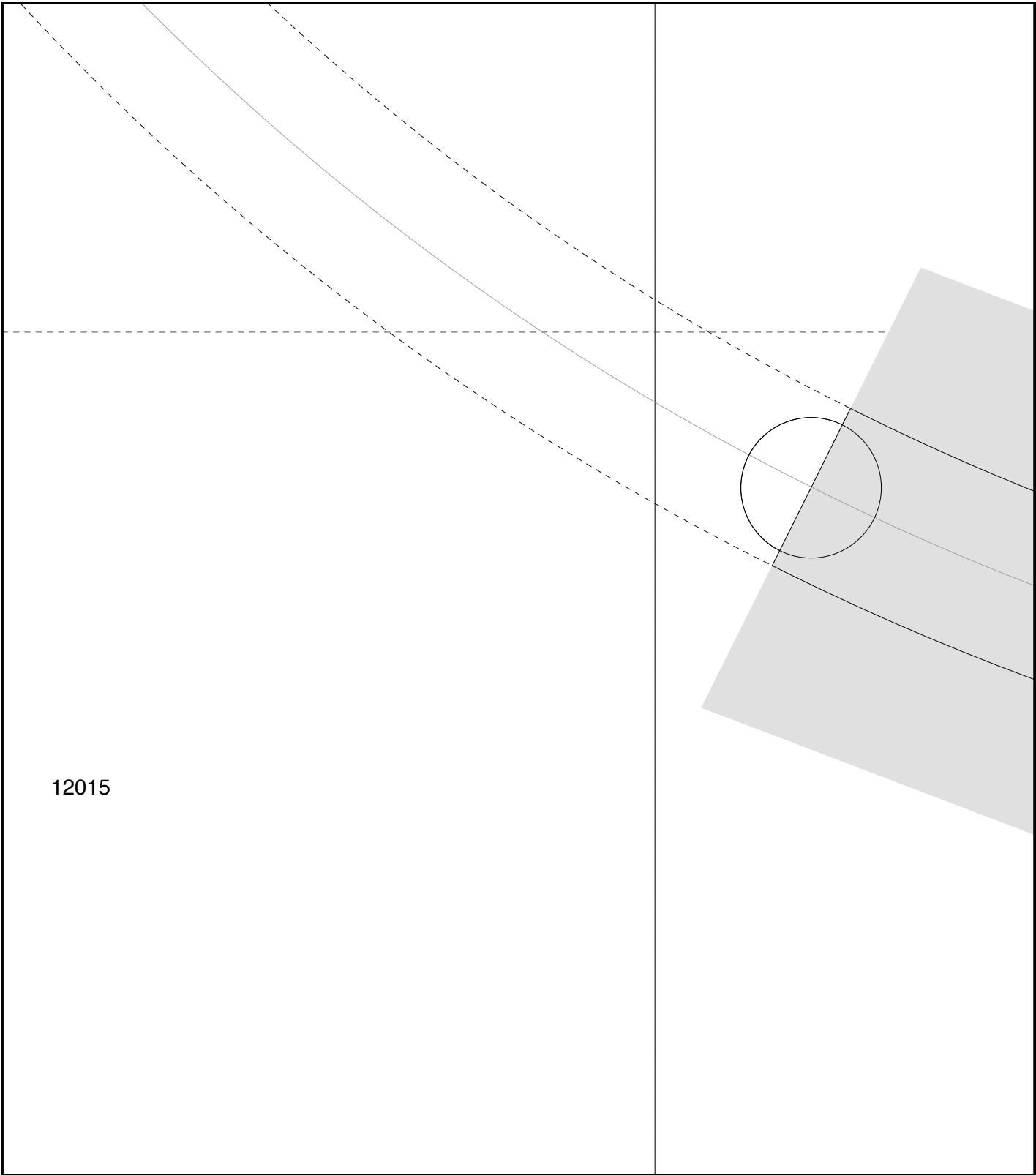

12015

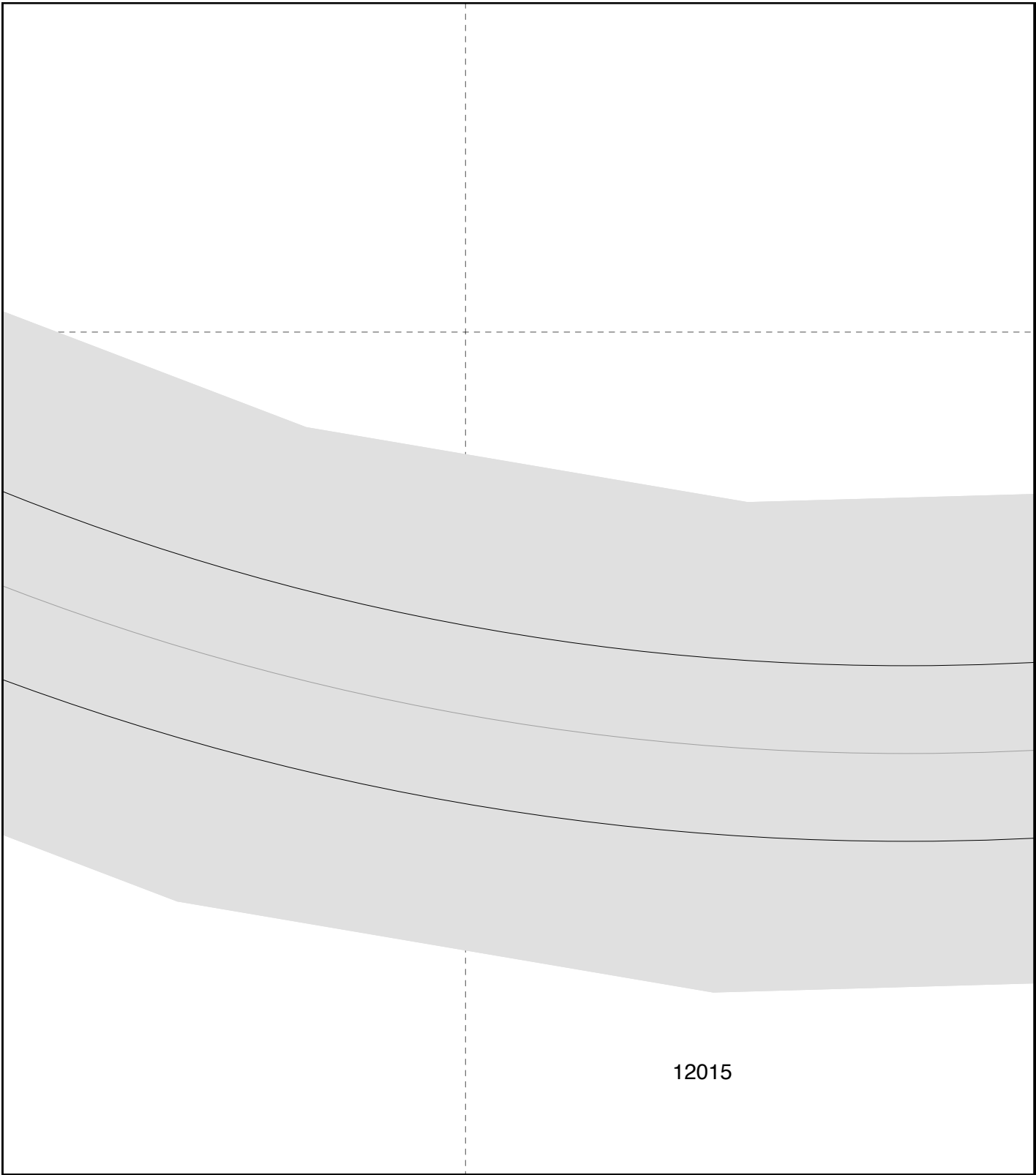



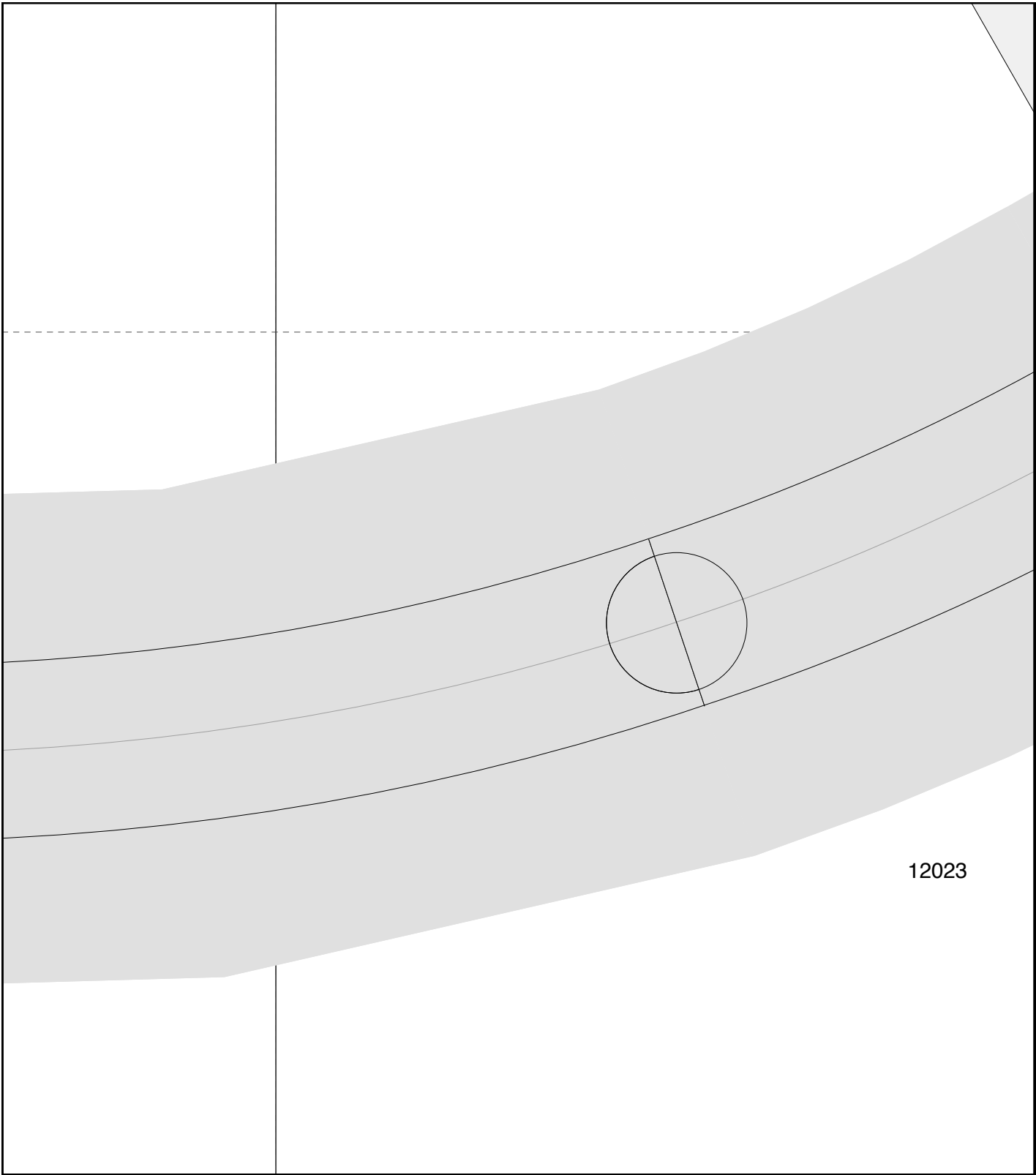

12023

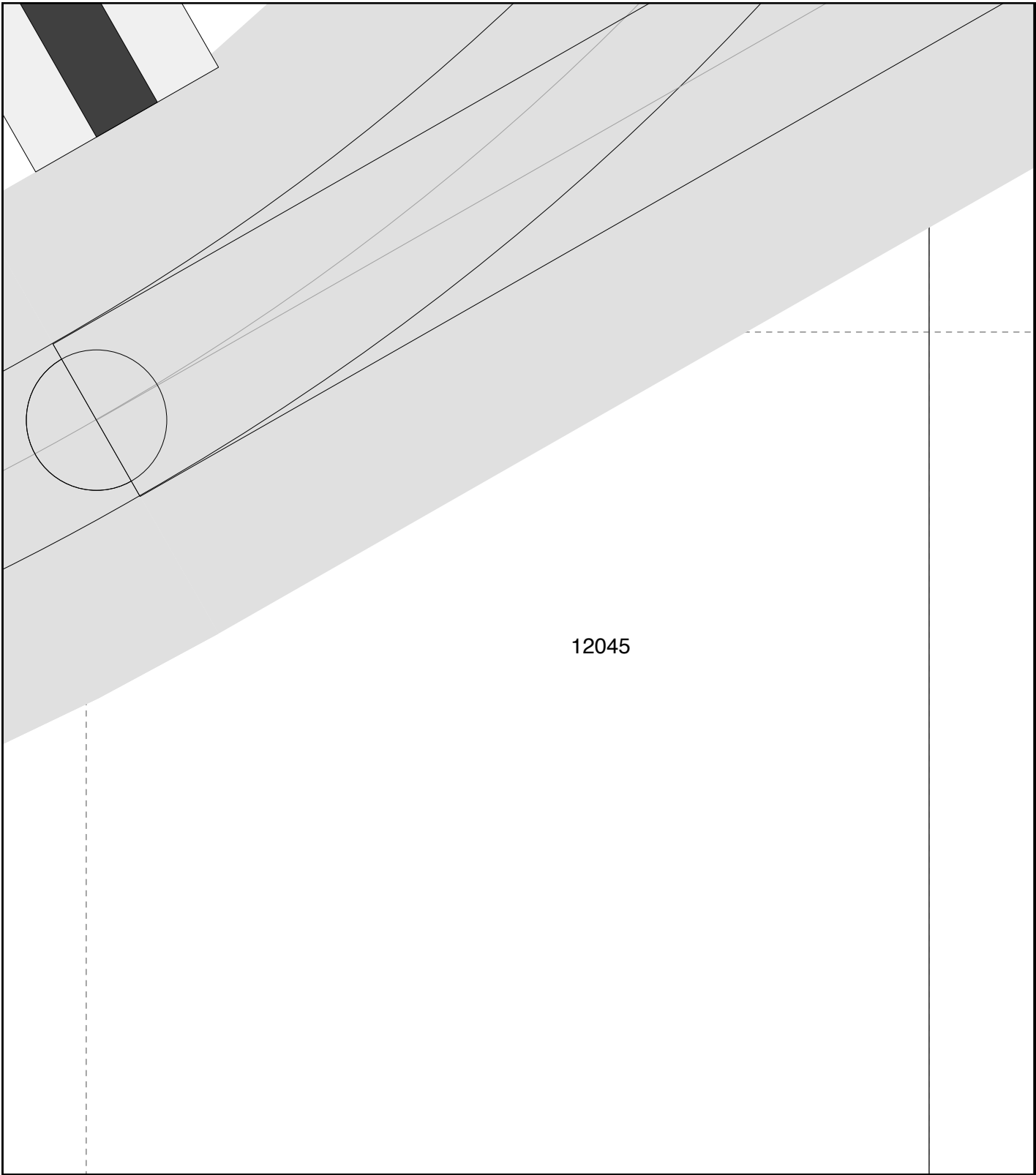

12045

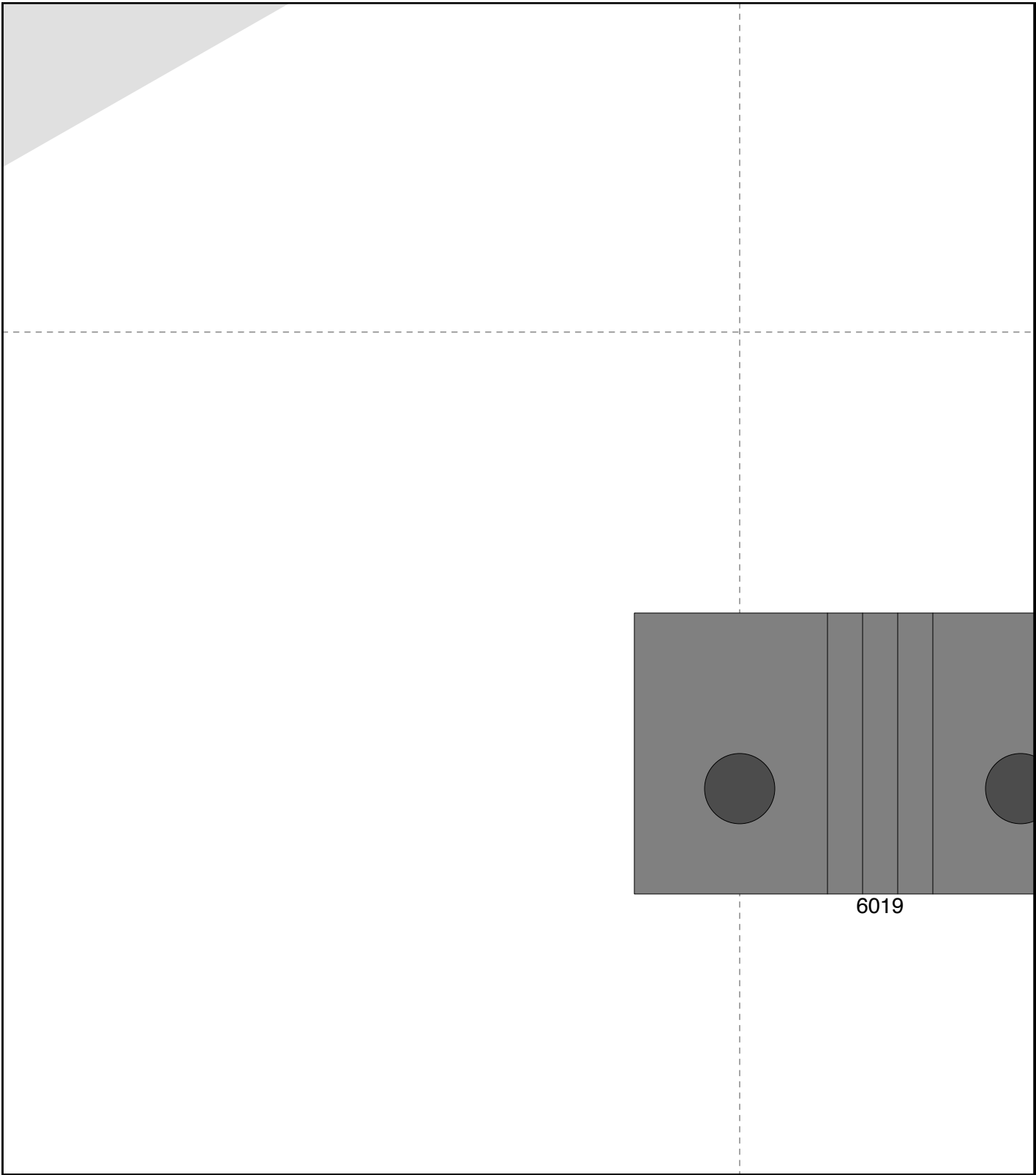

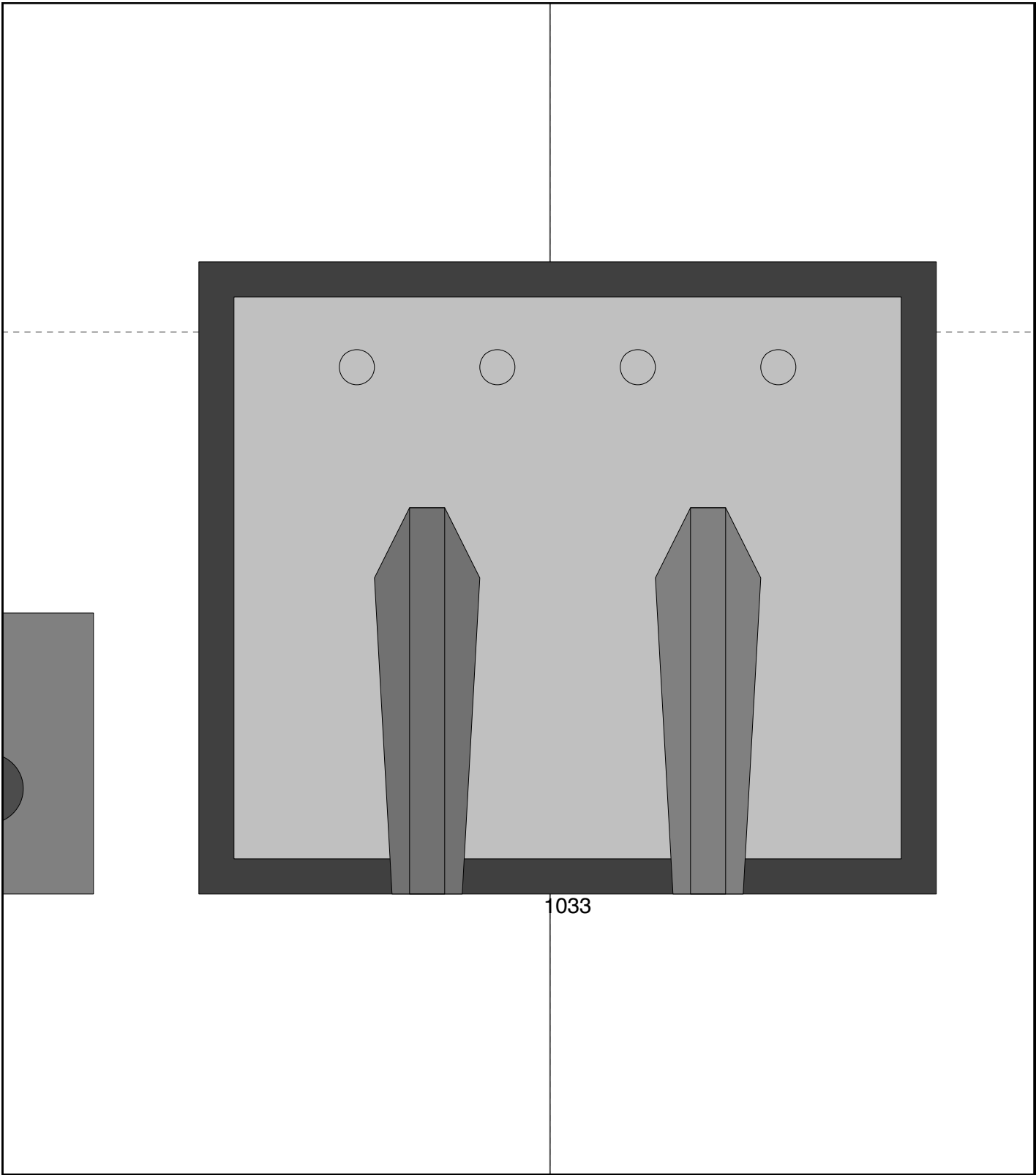

1033

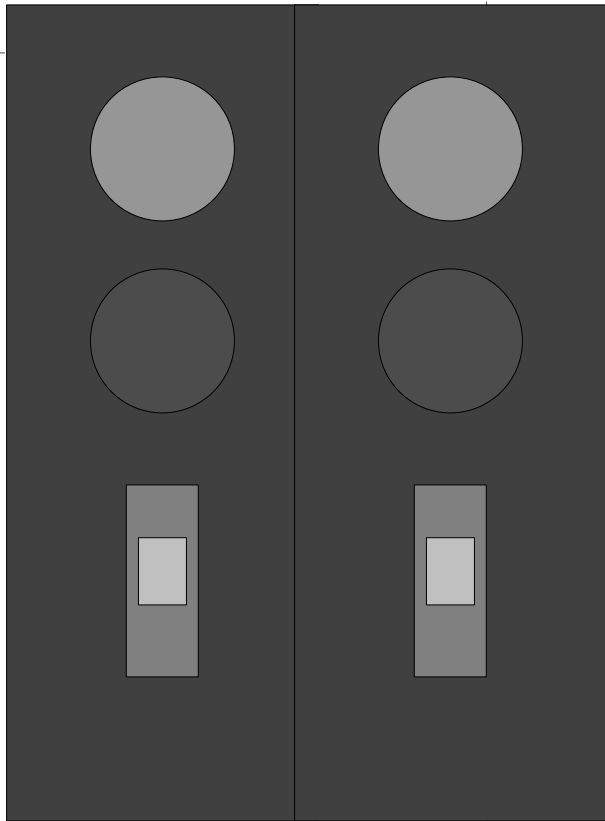

O22C

O22O

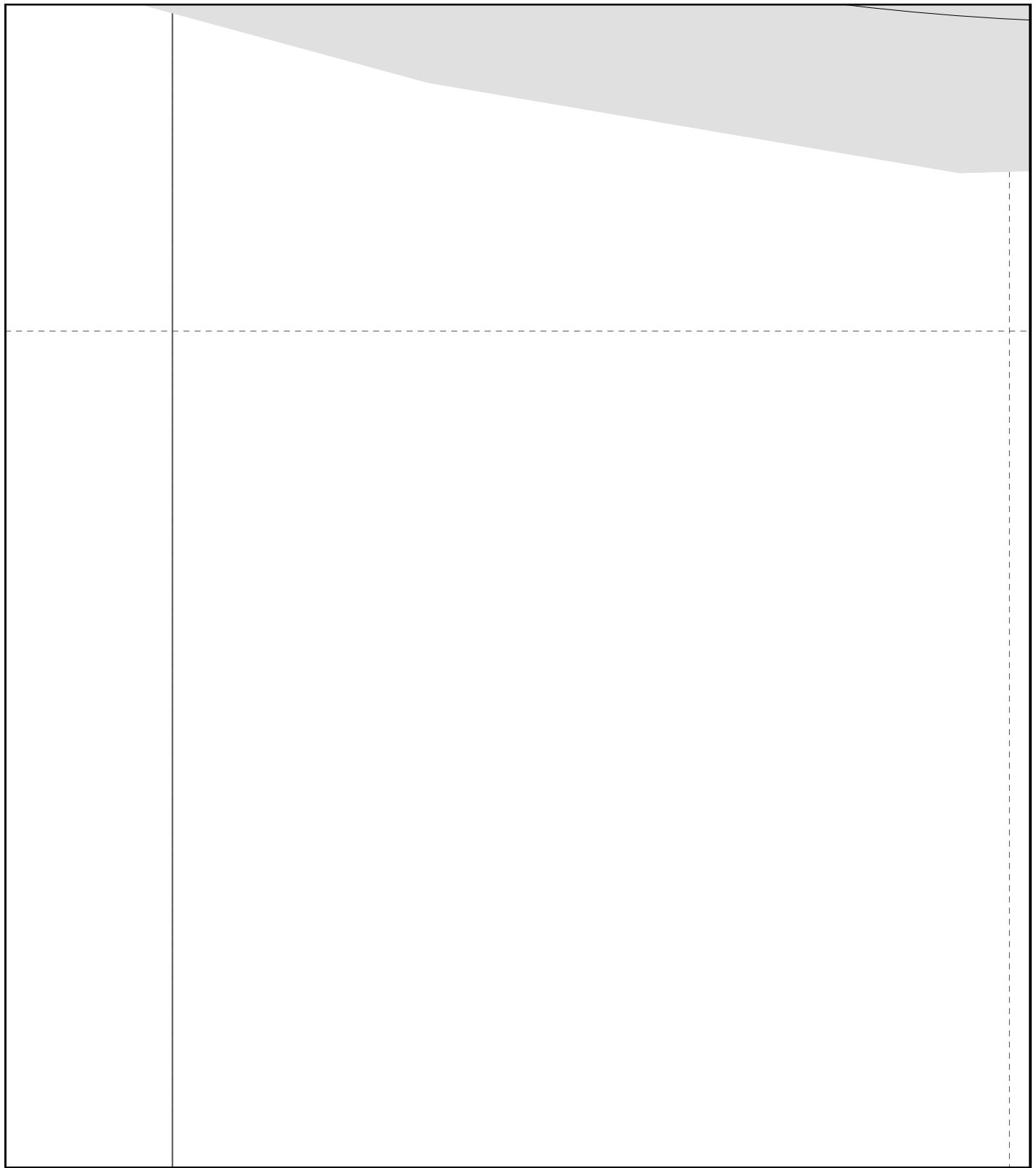

12015

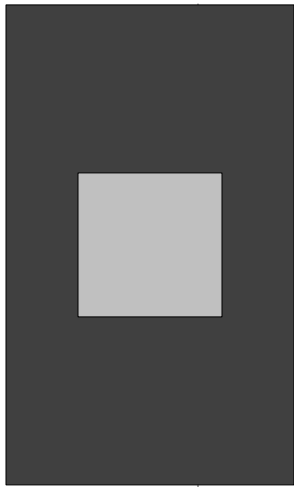

364C



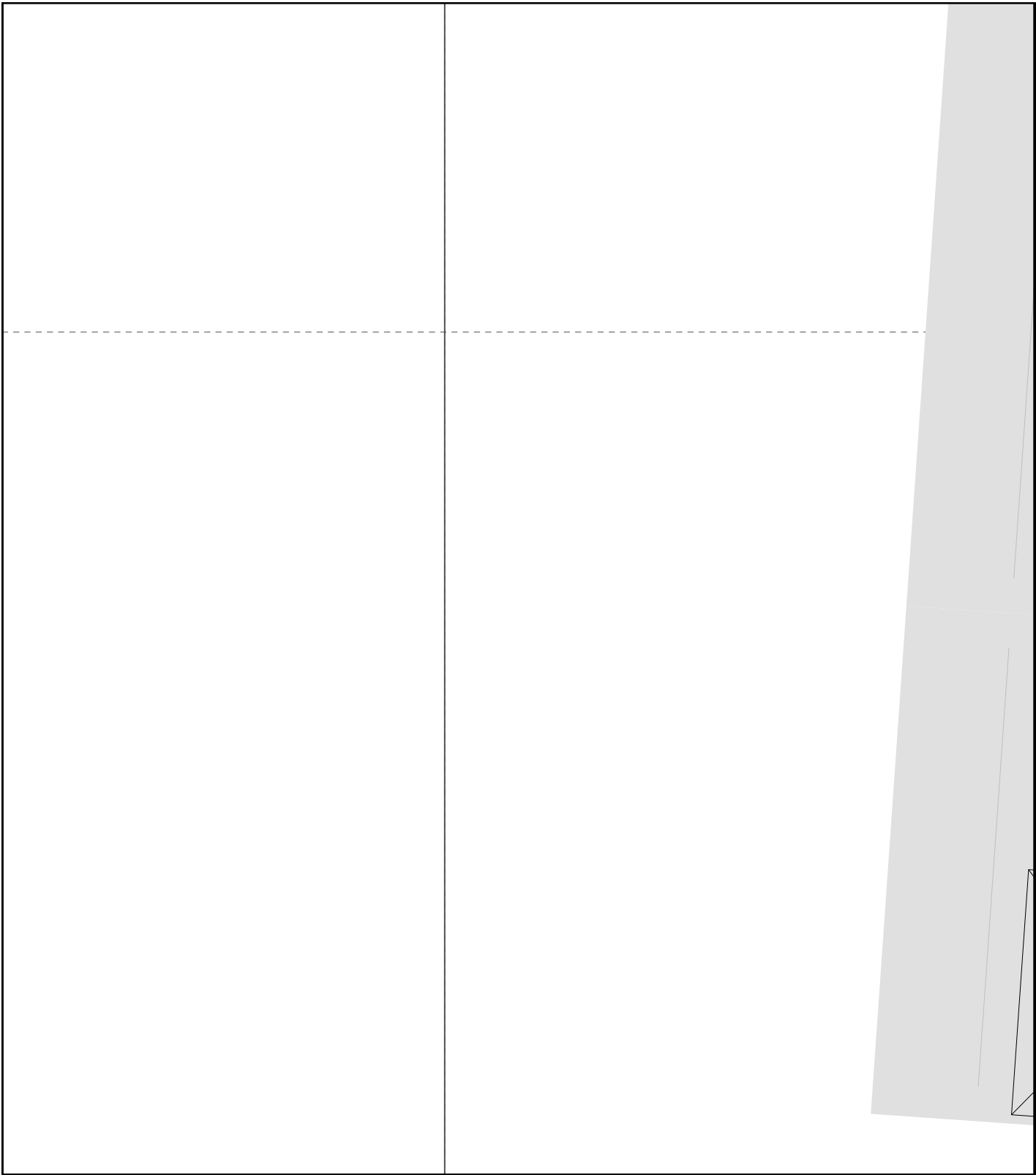

12020

12025

12059

